



Fire Alarm Control Panel PL-1000

Installation and User Manual

M-169.1-SERIE-PL-EN Version 2023 / 04.2024

Intended purpose

This product may be used only for the applications outlined in the catalogue and in the technical description, and only in conjunction with the recommended and approved external devices and components.

This documentation contains registered and unregistered trademarks. All trademarks are the property of the respective owners. The use of this documentation does not grant you a license or any other right to use any name, logo or label referred to or depicted herein.

This documentation is subject to the copyright of Honeywell. The content must not be copied, published, modified, distributed, transmitted, sold or changed without the express prior written permission of Honeywell.

The information contained in this documentation is provided without warranty.

Safety-related user information

This manual includes information required for the proper use of the products described.

In order to ensure correct and safe operation of the product, all guidelines concerning its transport, storage, installation, and mounting must be observed. This includes taking the necessary care when operating the product.

The term 'qualified personnel' in the context of the safety information included in this manual or on the product itself designates:

- project engineers who are familiar with the safety guidelines concerning fire alarm and extinguishing systems.
- trained service engineers who are familiar with the components of fire alarm and extinguishing systems and the information on their operation as included in this manual.
- trained installation or service personnel with the necessary qualifications for carrying out repairs on fire alarm and extinguishing systems, or who are authorized to operate, earth and label electrical circuits and/or safety equipment/systems.

Symbols

The following information is provided in the interests of personal safety and to prevent damage to the product described in this manual and all equipment connected to it. Safety information and warnings to prevent hazards endangering the life and health of users and maintenance personnel, as well as causing damage to the equipment itself, are indicated by the following pictograms. Within the context of this manual, these pictograms have the following meanings:



Warning - designates risks for man and/or machine. Non-compliance will result in risks to man and/or machine. The level of risk is indicated by the word of warning.



Note - important information on a topic or a procedure and other important information.



Standards and guidelines - observe configuration and commissioning information in accordance with the national and local requirements.



This symbol precedes information about compliance with standard(s).

Dismantling



In accordance with Directive 2012/19/EU (WEEE), after being dismantled, electrical and electronic equipment is taken back by the manufacturer for proper disposal.

© Honeywell International Inc./technical changes reserved!

This documentation is subject to copyright law and, as per Sections 16 and 17 of the German Copyright Act (UrhG), may be neither copied nor disseminated in any other way. Any infringement as per Section 106 of the UrhG may result in legal action.

Contents

| | | |
|------|---|----|
| 1 | GENERAL / APPLICATION | 5 |
| 1.1 | Precautions | 6 |
| 1.2 | CE marking and information | 7 |
| 1.3 | National Standards..... | 7 |
| 2 | TRANSPORT DAMAGE INSPECTION | 8 |
| 2.1 | Pre-installation check list..... | 9 |
| 3 | INSTALLATION OVERVIEW..... | 10 |
| 4 | SPECIFICATIONS..... | 11 |
| 4.1 | Mechanical specifications | 12 |
| 4.1 | Electrical specifications | 13 |
| 4.3 | Environmental specifications..... | 13 |
| 5 | PANEL PARTS – FRONT VIEW | 14 |
| 5.1 | Panel parts – Internal view..... | 15 |
| 6 | PANEL INSTALLATION | 17 |
| 6.1 | Surface mounting | 18 |
| 7 | CABLING..... | 19 |
| 7.1 | Mains and battery connections..... | 21 |
| 7.2 | PL-1000 connections overview..... | 22 |
| 7.3 | Optional Loop Module (PL-LIB-01) - Installation Overview..... | 23 |
| 7.4 | Serial Port Connections Overview | 24 |
| 8 | DETECTORS AND MODULES OVERVIEW..... | 25 |
| 9 | DISPLAY AND CONTROLS..... | 26 |
| 10 | SYSTEM DEFAULT PASSWORD | 28 |
| 11 | DISPLAY OVERVIEW | 29 |
| 11.1 | Display indications and buttons | 30 |
| 12 | CONFIGURATION MENU..... | 31 |

Fire Alarm Control Panel PL-1000

| | | |
|------|--|----|
| 13 | PROGRAM MENU..... | 32 |
| 13.1 | Configuration – access to menu..... | 33 |
| 13.2 | Configuration - Date and Time setting | 34 |
| 13.3 | Configuration – Panel configuration | 36 |
| 13.4 | Configuration – Peripherals option | 39 |
| 13.5 | Configuration – Autoprogram | 41 |
| 13.6 | Configuration – Description..... | 42 |
| 13.7 | Configuration – Matrix / Cause and effect I-O | 44 |
| 13.8 | Configuration – Activation delay..... | 47 |
| 14 | OPERATION - ENABLE / DISABLE ZONE AND POINT | 49 |
| 15 | OPERATION - ENABLE / DISABLE SOUNDERS..... | 50 |
| 16 | SYSTEM STATUS..... | 51 |
| 16.1 | System status – Wireless devices (this functionality will be available on next Firmware release) | 51 |
| 16.2 | System status – Panel Diagnostic values..... | 52 |
| 16.3 | System status – Points Diagnostic values | 53 |
| 17 | HISTORY LOG..... | 54 |
| 18 | VERSIONS | 55 |
| 19 | SYSTEM TEST..... | 56 |
| 19.1 | System test - User interface and relay..... | 56 |
| 19.2 | System test – Zones | 57 |
| 19.3 | System test – Outputs..... | 58 |
| 19.4 | System test – Sounders..... | 59 |
| 20 | MAINTENANCE | 60 |
| 21 | UPGRADING PANEL FIRMWARE..... | 61 |
| 22 | FRONT LABEL LANGUAGES AVAILABLE | 65 |
| 23 | PRODUCT LIST | 66 |
| 23.1 | Compatible Devices | 66 |

1 GENERAL / APPLICATION

The purpose of this manual is to provide the user with instructions concerning installation, use and maintenance of the PL-1000 Fire Alarm Control Panel (FACP).

SYSTEM EQUIPMENT

The analogue-addressable PL-1000 FACP is medium in size and very easy to install and configure. The system is designed to manage both traditional wired field devices and Agile wireless equipment. Installation and commissioning time are reduced to a minimum since the user interface allow in few steps to commission and tests field devices.

PL-1000 is a single loop addressable panel expandable to two loops with an optional loop card. Each loop supports 159 detectors and 159 input / output modules.

PL-1000 includes Honeywell's Advanced protocol, which maximizes the speed and efficiency of alarm detection, as well as providing maximum information to the installer.

The 4,3" / 109,2 cm (480 x 272 pixel) Touchscreen provides an intuitive user interface via its touch screen and menus with quick, and easy system operation. The FACP allows configuration from the screen itself.

Due to its size and power, it is the ideal analogue addressable panel for small-medium sites, where maximum information is required from the installed devices. The panel allows the identification of each of the addressable sensors, with different levels of alarm, to verify the state of the system, before carrying out any evacuation or transmission to the alarm receiving station or to the building management system.



Do not try to use the control unit and connected devices without reading this manual!

1.1 Precautions



- These instructions contain procedures to be followed to avoid damage to equipment. It is assumed that the user of this manual has completed a training course and that he knows the applicable rules that are in force.
- The system and all its components must be installed in an environment with the following conditions:
 - Temperature: -5 °C ... +40 °C
 - Humidity: 10 % ... 95 % (non-condensing)
- Peripheral devices (sensors, etc.) which are not perfectly compatible with the control unit may cause damage to the control unit or cause the system to malfunction at any time. It is therefore essential to only use material which is guaranteed by Honeywell and is compatible with its control units.
- Please consult Honeywell Technical Service if in any doubt.



- This system, like all solid-state components, may be damaged by induced electrostatic voltages. Handle the boards by the edges and avoid touching the electronic components.
- In any case, appropriate earthing ensures a reduction in sensitivity to disturbances.
- Please consult Honeywell Technical Service if you cannot solve installation problems.
- No electronic system will operate if it is not supplied with power.
- If the mains power supply fails, the system will still operate using battery power, but only for a limited period.
- During the system planning phase, consider the authority required to ensure the power supply and batteries are appropriately dimensioned.
- Skilled personnel must periodically check the condition of batteries.
- Disconnect the MAINS and the batteries BEFORE removing or inserting any board.
- Disconnect ALL power supply sources from the control unit BEFORE performing any servicing.
- The control unit and the connected devices (sensors, modules, repeaters, etc.) may be damaged if a new board is inserted or removed, or if the powered cables are connected.
- The most common cause of malfunctions is inappropriate maintenance.
- Pay particular attention to these aspects from the start of the system planning phase; this will facilitate future servicing and will reduce cost.

1.2 CE marking and information

This document is a declaration that the products listed below conform to the essential protection requirements of the following European Directives:

- RoHS - Restrictions on the Use of Certain Hazardous Substances in Electrical and Electronic Equipment
- Equipment Directive 2011/65/EU
- Compliance with RoHS 2 - Product does not contain any hazardous substances above the limits designated in the RoHS Directive. Product falls within Category 9 - Monitoring and Control instruments

The EMC Directive 2014/30/EU, by the application of the following EMC Standards:

- EN 61000-6-3:2007 +A1: 2011 (Emissions)
- Electromagnetic compatibility (EMC) Generic emission standard for residential, commercial, and light industrial environments
- EN 50130-4: 2011 +A1: 2014 (immunity)
- EMC Product family standard. Immunity requirements for components of fire, intruder, and social alarm systems
- Low Voltage Directive 2014/35/EU
- CPR Directive 305/2011

1.3 National Standards

- This equipment must be installed and operated in accordance with these instructions and the appropriate national, regional, and local regulations, specific to the country and location of the installation. Consult with the appropriate Authority Having Jurisdiction (AHJ) for confirmation of the requirements.
- This equipment must be installed in accordance with these instructions and the appropriate national, regional, and local wiring regulations.



This device must be installed and must operate in accordance with these instructions and to the rules in force in the installation place.



EN54-2 13.7

Maximum of 512 Sensors / Manual Call Points per panel.



Additional and updated Information

The described features, specifications and product related information in this manual correspond to the date of issue (refer to date on the front page) and may differ due to modifications and/or amended Standards and Regulations of the System design, Installation and Commissioning. Updated information is available for comparison on the MORLEY IAS Fire Systems homepage.

2 TRANSPORT DAMAGE INSPECTION

Please check all of the packaging and components for damage before commencing the assembly and installation work. Do not assemble or install visibly damaged modules and components!

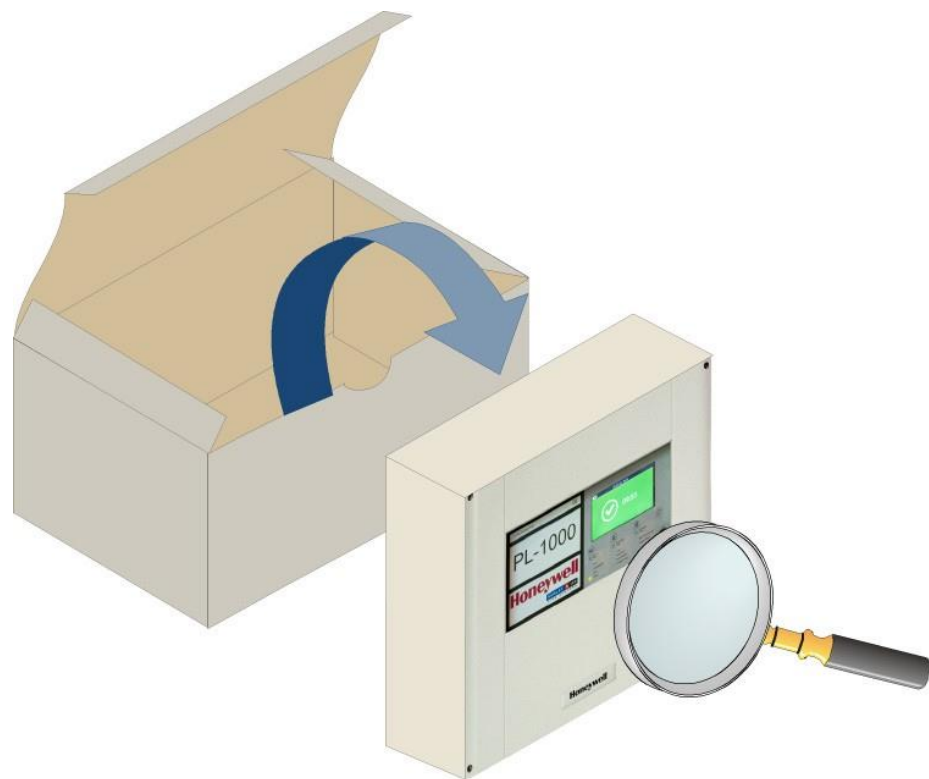

Fig. 1: Checking for damage

It is important to check all supplied equipment for damage before proceeding with the installation! Before attempting to install the PL-1000 FACP, or other equipment, you must do the following:

1. After removing the FACP, modules and other related equipment from its packaging, and before you proceed with installing it in its chosen location, check for any damage that may have occurred while in transit.



In the unlikely event that any of the supplied FACP items has been damaged, you **MUST NOT** install it but return it to your supplier, see the following section.

2. If you are satisfied that none of the supplied items has been damaged, you can now proceed with installation. Refer to the relevant sections that apply to your installation/configuration requirements.



Danger – Electrical shock!

Remove all power from the FACP before carrying out any installation work!

ESD protection

While handling electronic assemblies, the necessary precautions against electrostatic discharge must be taken.

WHAT TO DO IF THE EQUIPMENT RECEIVED IS DAMAGED

If you have problems regarding the quality of any supplied order items including the FACP, its ancillaries or items are missing, follow the procedure below.

1. DO NOT continue with the installation but, contact your supplier for advice on what to do next. Similarly, if the product is found to be faulty during installation contact your supplier immediately.
2. To aid your supplier and the manufacturer, you are requested to quote the manufacturer's unique batch reference number, which can be found on the packaging or inside the back box.
3. Note all the details relevant to your complaint, date of receipt, packaging condition and forward it to your supplier.
4. Were the product needs to be returned to your supplier, you are requested to use the original packaging, or suitable anti-static equivalent, wherever possible.

2.1 Pre-installation check list

Before installing the PL-1000 FACP you must first ensure that the following criteria have been met. Failure to do this, may not only result in damage to the equipment but may also cause problems during commissioning operations, or adversely affect its performance:

- DO ensure the operating ambient temperature where the panel is installed is in the range: -5 °C ... +40 °C.
- DO Ensure the panel is installed where the relative humidity is between 5 % ... 95 % non-condensing.
- DO Ensure the panel is installed in an area where solids and liquid entering is not beyond IP 30 rating.
- DO NOT site the panel where there would be restricted access to the inside of the equipment and to the internal cabling and wiring connections points.
- DO NOT locate the panel where there are high levels of vibration or shock.

TRANSIENT PROTECTION

This equipment contains transient-protection devices. Although no system is completely immune from lightning transients and interference, to allow its correct functionality and to reduce susceptibility, this equipment must be earthed correctly.

As with all static sensitive electronic components, this system may operate erratically or can be damaged if subjected to lightning-induced transients. The use of overhead or outside aerial wiring is not recommended, due to the increased susceptibility to nearby lightning strikes.

3 INSTALLATION OVERVIEW

The panel range is designed for mounting onto an internal wall of a protected building and is not suitable for mounting on outdoor applications.

1. Install the panel housing in accordance with the instructions reported in this manual.
2. Bring the field wiring/cables through the recommended entry points on the backbox. Prepare all cable/wiring entry with appropriate fire industry-approved cable glands and label all field wiring correctly to aid termination.
3. Install a fire industry-approved, AC mains power supply isolator 'fused spur unit' close to the FACP. The mains supply cable must be brought into the housing, using a recommended cable entry point.
4. Use this manual for recommendations on how to install batteries inside the housing.
5. Once individual cables are checked, make the wiring of each circuit. The battery link is fitted during the commissioning power up stage.

4 SPECIFICATIONS

- 4,3" / 109,2 cm Touch-screen graphical color display, 480 x 272 pixel with back illumination and backlit membrane buttons
- One loop expandable to 2 loops with an optional expansion card
- Each loop manages up to 159 detectors plus 159 input/ output modules.
- 16 Zones
- Fire and Fault C/NC/NO dry contact relays.
- 1 24 V DC, User load max. 500 mA
- 2 Digital Inputs
- Two sounder circuits load max. 250 mA each
- Output delays max. 10 minutes (according to EN 54)
- 10 Illuminated status LED: Power, Fire, Disablement, Test, Fault, System Fault, Earth Fault, Power Supply Fault, Aux Power Supply Output Fault, Sounder Fault/Disablement
- 4 operating buttons: Reset Panel, Silence Buzzer, Silence Sounders, Evacuate
- 3 confirmations LED: Buzzer Mute, Sounder Stop, Evacuate
- 1 mechanical key
- The internal panel buzzer provides an audible alert to the authorized user, to take immediate action whenever the system detects any condition such as a fire or fault event. Depending on the type of event, the buzzer activates (sounds) using a different tone pattern. The SILENCE BUZZER control button is used to silence (mute) the internal buzzer after it has switched on following an event. This control is available at all access levels, without a need for PIN code.
- AC power supply with different plug options with a max. rate power of 65 W
- Autonomy in standby and alarm time, in absence of main power, are based on the system configuration. Please refer to Honeywell Loop Calculator for more details
- Batteries: 2 x 12 V DC / 7 Ah (Recommended Yuasa batteries)
- Log and configuration through USB port type B, available in future releases.
- $I_{min} = 180 \text{ mA}$
- $I_{maxa} = 380 \text{ mA}$
- $I_{maxb} = 1,3 \text{ A}$
- Maximum $R_{iMin} = 0,63 \text{ Ohm}$
- Certified EN 54-2 / AC / A1
- Certified EN 54-4 / A1 / A2
- Certified LVD 62.368-1:2014+A11

4.1 Mechanical specifications

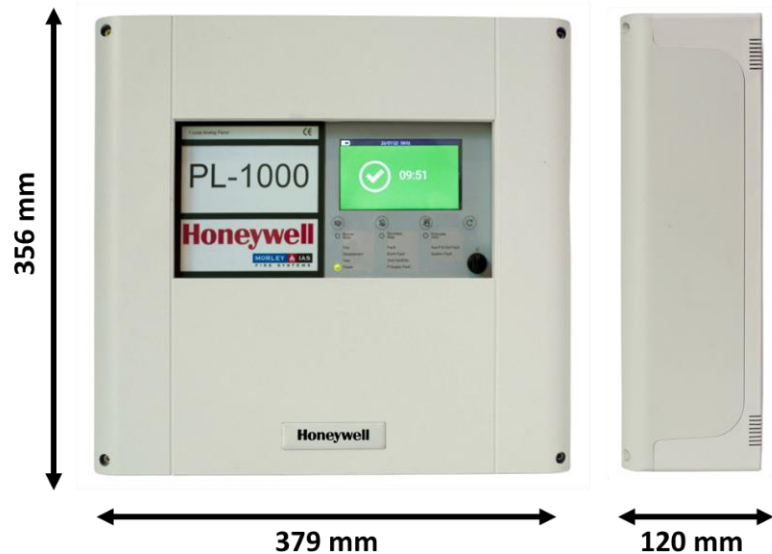

- Dimensions in mm: 379 x 356 x 120 (width x height x depth)
- Upper 15 cable glands Ø 21 mm
- Back 8 cable glands Ø 21 mm
- Cable entry easy to break
- Housing color: RAL 9002
- Material: ABS flame retardant UL94 class V-0
- Weight: 1760 g

Fig. 2: Dimensions



Fig. 3: Front View



Fig. 4: Side View



Fig. 5: Top View



Fig. 6: Back View

4.1 Electrical specifications

- External power supply: 100 ... 240 V AC, 50 ... 60 Hz
- AC Fuse: 4 A / 250 Vac / 5 x 20 mm (slow blow)
- Power consumption: max. 65 W
- 2 → Supervised sounder outputs each with max. 250 mA
- 1 → 24 V DC, User load max. 500 mA
- 2 → Digital Inputs
- 1 → Alarm relay C/NC/NO dry contacts
- 1 → Fault relay C/NC/NO dry contacts
- Max. 1.500 m distance depending on the cable section and current consumption in alarm.
- Rmax battery: 1,4 Ohm
- Battery fuse: 4 A / 250 Vac / 5 x 20 mm (fast acting)

4.3 Environmental specifications

- Climate classification: K5 (IEC 721-2-3)
- Temperature range: -5 °C ... 40 °C
- Relative humidity: 5 % ... 95 % non-condensing
- Protection rating: IP 30 (acc. EN 60529)

5 PANEL PARTS – FRONT VIEW

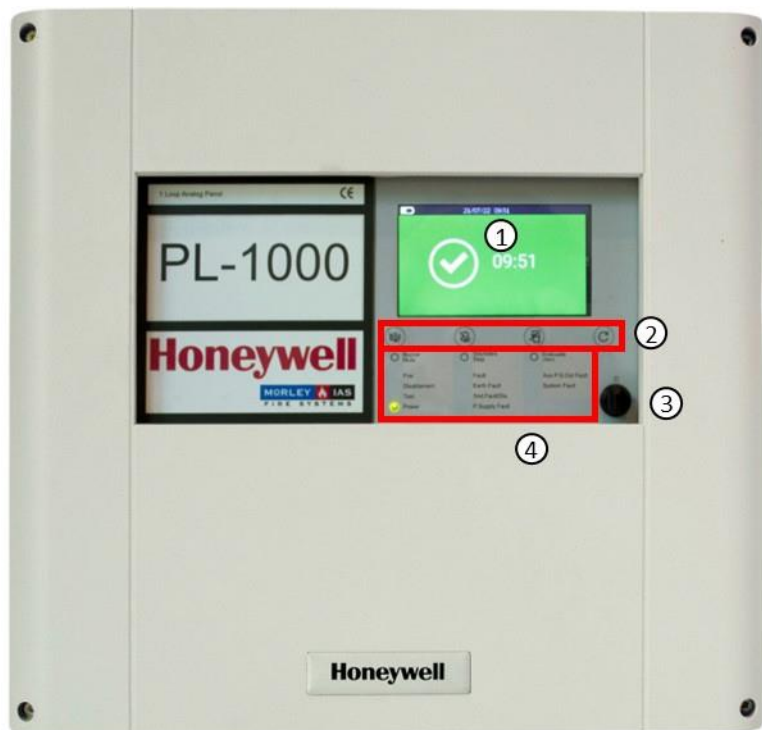

Fig. 7: Front view

| | |
|---|----------------------|
| ① | Touch-screen Display |
| ② | Functional Buttons |
| ③ | LED Indicators |
| ④ | Mechanical Key |

5.1 Panel parts – Internal view

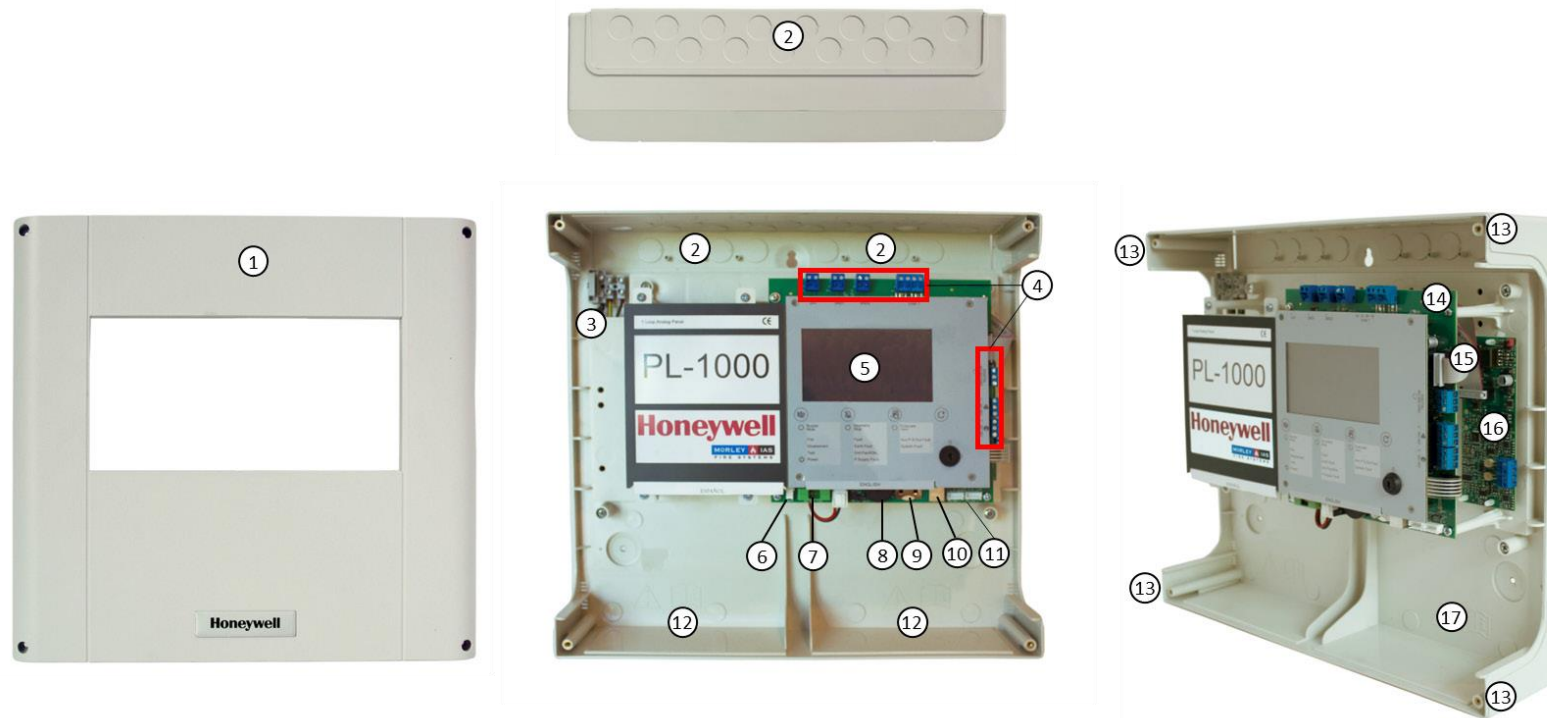

Fig. 8: Internal view

| | | | | | |
|----------|-------------------|-----------|--------------------|-----------|-------------------------------|
| 1 | Front Cover | 7 | Battery Fuse | 13 | Panel Closing Screws |
| 2 | Cable Entry Holes | 8 | Buzzer | 14 | Main Board |
| 3 | Main Connector | 9 | RCT Battery | 15 | Loop Expansion Card Connector |
| 4 | Terminals | 10 | USB Port B Type | 16 | Loop Expansion Card |
| 5 | Display | 11 | Serial Ports | 17 | Rear Cover |
| 6 | Battery connector | 12 | Batteries Location | | |



Fig. 9: Batteries type Yuasa NP7-12FR 2 x 12 V DC / 7 Ah (example)



Batteries used within this product may only be replaced by batteries that are in compliance with IEC 60896-11, IEC 60896-21, IEC 60896-22, IEC 61056-1 and IEC 61056-2 or IEC 62485-2 and made of material with flammability rating V-1 or better.

6 PANEL INSTALLATION

The equipment must be installed indoors, with requirements refer chapter 4.3.

The installation of the panel must be carried out by qualified personnel. The electronic components that make up of the equipment, are vulnerable to physical damage or electrostatic discharge. It is advisable to take anti-static precautions.

The equipment must be installed on a flat, dry surface at eye level and so that the housing is not deformed.



Use the fastening elements provided or similar ones, adapting them to the type of surface.

The cables must be inserted inside the box through suitable means (cable glands, not provided), avoiding rubbing with the metal edges of the box. Use the pre-cut opening provided.

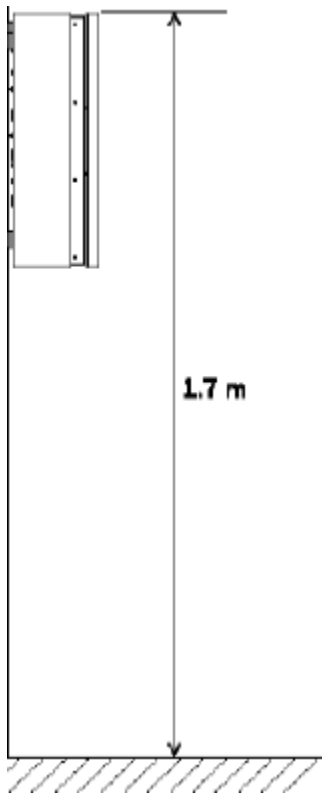

The panel must be mounted on a wall at a height of 1,70 m above floor level, such that the display is just above normal eye level.

Fig. 10: Mounting hight

6.1 Surface mounting

The PL-1000 FACP can be surface mounted onto a flat wall, using suitable fixtures and fittings (height between 80 ... 170 cm). As a general recommendation for type of wall surfaces, ensure assessments are made and suitable fixtures and fittings are used to hold the panel assembly. The panel backbox is mounted on a concrete block wall.

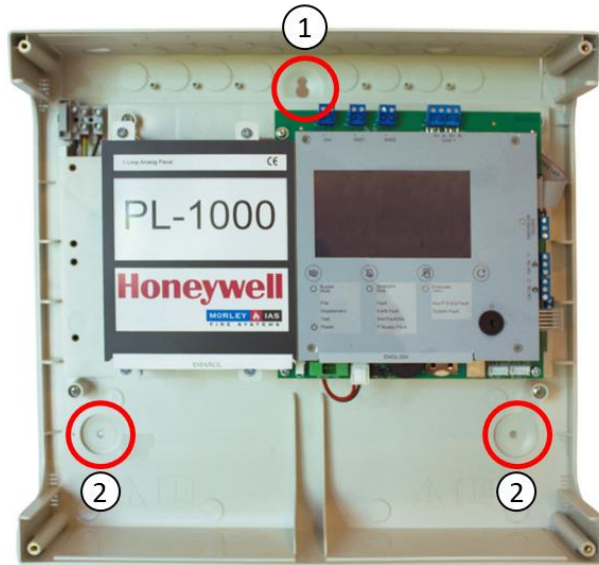

Fig. 11: Mark the required hole

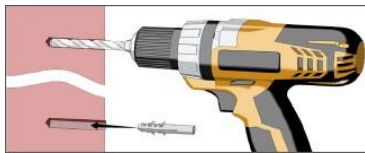

Fig. 13: Drill holes

STEP 1

Hold the panel backbox horizontally (align using a spirit level) on the mounting surface and mark the 3 mounting holes.

STEP 2

Drill the wall on the three fixing points and utilize the accessories included with the panel (3,5 x 25 mm) to secure the panel on the wall.

STEP 3

Mounting backbox

Put the screw in the hole ①, align the screw on the cover with the keyhole on the back, then insert the screws on the holes ② to complete panel installation.

CABLE ENTRIES

- Upper 15 cable glands Ø 21 mm
- Back 8 cable glands Ø 21 mm
- Cable entry easy to break



Fig. 12: Cable Entries

7 CABLING



All wiring must comply with local regulations. Also observe the requirements for cabling and interconnection of a fire detection and alarm system. For information on how to wire compatible field devices, please refer to the related product documentation.

CABLING INSTRUCTIONS

1. Cables must be brought into the housing using the 20 mm cable entry points provided on the top and rear of the panel housing. Ensure that all openings in the housing are closed before connecting power to the panel, to prevent inadvertent access to hazardous voltages.
2. Tails must be of sufficient length to connect to the respective terminal at the commissioning stage.
3. Cables that are screened must be terminated at the panel housing and earthed at points provided on the top side.
4. The mains supply must be suitably fused and rated as per specifications. Mains supply must have a dedicated path from the site distribution board, with an over-current protection device rated capacity of max. 16 A.
5. The cable entry points on the extreme right-hand side must be used for mains cable entry. DO NOT route mains cable using any other cable entry points and ensure that the mains wiring is always separated from the low voltage wiring. It is good practice to always isolate the mains power at the external isolator equipment, to make the panel safe when performing maintenance tasks, involving the panel's electronic equipment.
6. All low voltage cables must have a min. 300 V AC rating.

CABLE GLANDS

Fire-industry-approved, M 20 cable glands must be used, made from metal or having flammability class V-1 rating or better.

CABLE TERMINATIONS

This section provides guidance on where to bring cables into the FACP housing for ease of termination. Ensure the following requirements are met:

1. The mains supply must be brought into the FACP such that the cable path to the mains terminals block is kept as short as possible.
2. All loop and ancillary cable terminations must be brought into the FACP housing using cable entry points close to their final connection points to respective terminals, to ensure tails are kept as short as possible. To facilitate this most, modules can be fitted to the required slot location on the module carrier.
3. Some cable entry points must be left unused to provide adequate mains supply input/signal cable segregation.

QUALITY OF CABLE

It is vitally important that good quality cable is used and that correct installation techniques are followed. In general, the following cable installation requirements must be met:

1. All cable sections must be circular to allow effective cable clamping using the cable glands.
2. The cable must be screened (sheathed) to provide protection against Radio Frequency Interference (RFI) and the screen must be connected to earth at the panel (earthing points are provided on the inside housing top side).
3. The cable screen must be continuous throughout the loop. Please connect the screen to a ground/earth point.

LOOP CABLE LENGTH

A loop consists of devices such as detectors and modules. The length of the loop cable used can be up to 1500 m and is significantly impacted by the cable type as well as the number of devices.

RECOMMENDED CABLES

Type of cable: 2 conductors (for their section refer to the table below)

- Twisted narrow pitch (5 / 10 cm)
- Shielded pair cable
- Max. admitted capacity: 0,5 μ F
- Max. resistance depending on the current loop in alarm (number of sounder / strobes activated simultaneously): 20 Ohm. Please refer to the Loop and battery calculator for loop length and maximum loop resistance.

CABLE SECTIONS

The proposed sections are referred to the total length of the line (in case of Class A loop and therefore when the loop is closed, it is considered the loop length) which, however, must not be longer than 1500 m and the total resistance of the line must be lower than 20 Ohm. Please refer to the Loop and battery calculator for loop length and maximum loop resistance.

| MINIMUM CABLE SECTIONS | |
|------------------------|-------------------------|
| Up to 500 m | 2 x 0,5 mm ² |
| Up to 1.000 m | 2 x 1,0 mm ² |
| Up to 1.500 m | 2 x 1,5 mm ² |

7.1 Mains and battery connections

Main voltage

Switch-off the 230 V AC main voltage at distribution switchboard. Before applying the mains voltage to the panel, make sure to carry out the following checks and procedures:

- Make sure that the power cable is led into the housing separately from the low voltage cables.

Prepare the power supply cable for connection as follow:

- Check that the main voltage is switched off.
- For safety reasons, remove the fuse from the mains supply and place in a safe place until the cable connection is complete.



Fig. 14: Mains connections

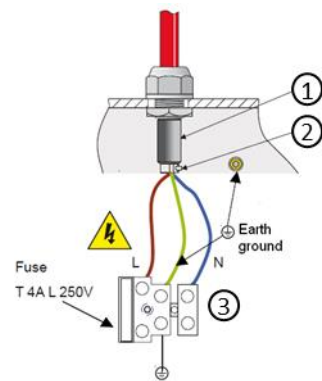

1. Remove the outer sheath of the cable ① to provide enough slack, approx. 80 mm, for the cables to help during connection.
2. From a loop with each conductor before presenting it on its terminal where it is to be connected. Guide the conductor L and N ② in such a way that there is a separation from the safety ground.
3. Connect the L and N conductors directly to the terminal block ③ (left and right terminal respectively). The safety ground conductor must be connected to the panel terminal.



The terminals accept cables from 1 to 1,5 mm².

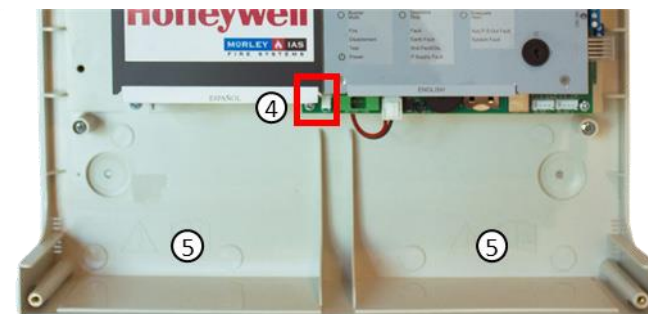
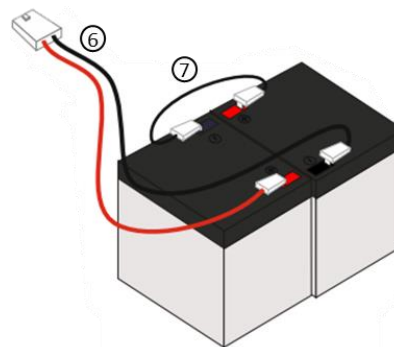

Fig. 15: Battery connection



Max. 2 x 12 V DC / 7 Ah batteries can be inserted in the FACP back box. In case of loss of the mains voltage the FACP will be powered without an interruption by the connected battery.

The FACP can work satisfactory only on batteries, if necessary, when the mains voltage is not available. However, this should be only for very short periods of time, to avoid unintentional discharge of the batteries.

1. Install the batteries inside the back box on the bottom ⑤.
2. The batteries shall be positioned in such a way their terminal is close enough to allow the connection of the short connection cable ⑦.
3. Connect the batteries using the supplied cable:
 - Connect the red and black (+ / -) cable plug to the main board ④.
 - Connect batteries with the short cable ⑦

7.2 PL-1000 connections overview



Fig. 16: Main Board connector sequence

Main Board Connections

| | |
|----|--|
| 1 | 24 V + |
| 2 | 24 V - |
| 3 | SND1 + |
| 4 | SND1 - |
| 5 | SND2 + |
| 6 | SND2 - |
| 7 | Loop 1 A+ |
| 8 | Loop 1 A - |
| 9 | Loop 1 B+ |
| 10 | Loop 1 B- |
| 11 | Digital IN 1+ Remote Silence Sounders |
| 12 | Digital IN 2+ Remote Reset |
| 13 | GND |
| 14 | Fault Relay Common |
| 15 | Fault Relay Normally Closed |
| 16 | Fault Relay Normally Open |
| 17 | Alarm Relay Common |
| 18 | Alarm Relay Normally Closed |
| 19 | Alarm Relay Normally Open |

Sounder circuit

End of line diode cathode marker on positive terminal.

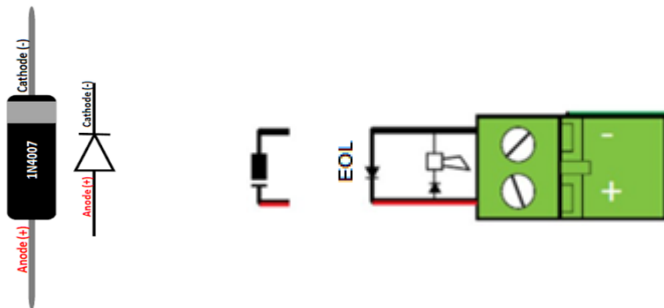
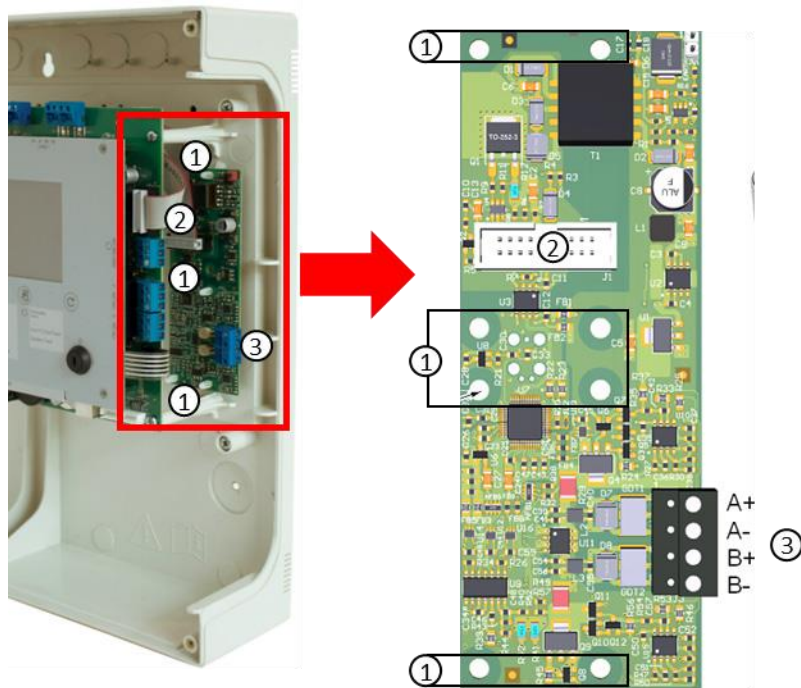

Fig. 17: Example of sounder circuit

7.3 Optional Loop Module (PL-LIB-01) - Installation Overview

The Optional Loop Module PL-LIB-01 add an additional loop the PL-1000 FACP, expanding the system up two loops in total. The loop supports up to 159 detectors plus 159 input / output modules.

The Module is fixed in the back box, beyond the main board, with the 8 plastic spacers. The ribbon cable grants the electrical connection to the main board.



Installation

1. Put the plastic spacers ① into the predisposed holes ① on the back box.
2. Connect the ribbon cable ② on the Loop Module PL-LIB-01.
3. Install the Loop Module onto the plastic spacer ①.
4. Connect the ribbon cable ② to the main board.

2nd Loop Connection ③

- Loop 2 → A+
- Loop 2 → A-
- Loop 2 → B+
- Loop 2 → B-

Fig. 18: Optional Loop Module connection with accessories

The PL-LIB-01 kit includes:



8 x plastic spacer ①.



1 x 20 pole ribbon cable ②

7.4 Serial Port Connections Overview

The panel is equipped with two serial ports RS-232 1 and RS-232 2 for connection to external systems using Third Party (TPP) and Plus Vision protocols. Pin connections for each serial port are as shown.

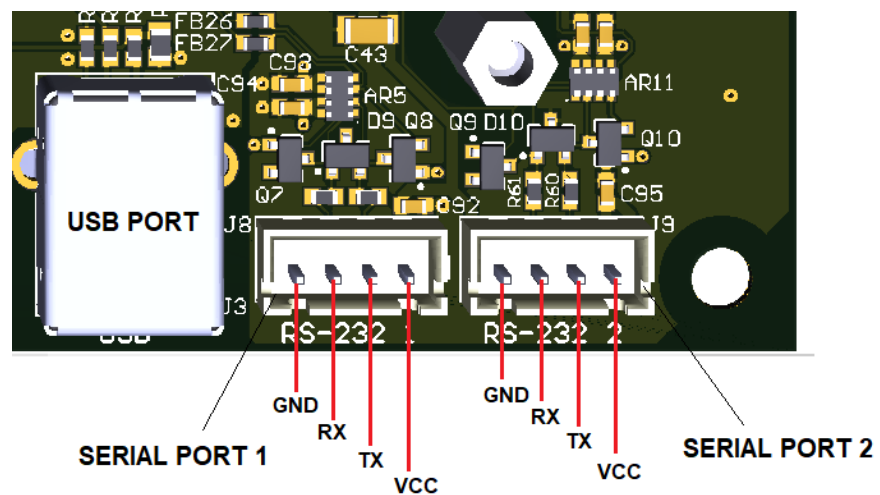

Fig. 19: Serial Ports and their pinout

8 DETECTORS AND MODULES OVERVIEW

A Detector device such as a Smoke or Heat detector:

- Has a given a unique "Address".
- Can be given a location label of up to 20 characters.
- It is associated to a "Zone".
- Has a working LED indicator on each device.
- Has a Remote LED option
- It is operating at its sensor sensitivity profiles.

A Module device such as an Input/Output Interface, Sounder-Strobe, Manual Call Point (MCP) on a loop:











- Has a given a unique "Address".
- Can be given a location label of up to 20 characters.
- It is associated to a "Zone".
- Has a working LED indicator on each device.









Please use the "Battery Calculator" tool to determine the limits of the field devices number in your installation.

9 DISPLAY AND CONTROLS

The Touchscreen display and LED indications, allow the user to review the system status and, with appropriate user PIN, have access and perform tasks in accordance with the requirements of the local fire regulations. There are 13 status icons provided on the front panel and 4 push buttons for event conditions.

| STATUS ICON | CONDITION / CONTROL | COLOR | DESCRIPTION |
|---|-------------------------------------|--|--|
|  | FIRE | Red (blinking) | A fire condition has been detected (buzzer active) |
| | | Red (fixed) | The user has acknowledged the event by buzzer silence |
|  | DISABLEMENT | Yellow (blinking) | A device or zone is disabled |
|  | TEST | Yellow (blinking) | A zone is in test mode |
|  | POWER | Green (fixed) | The system is switched on and the power is supplied via the mains |
|  | FAULT | Yellow (blinking) | General fault, buzzer is active |
| | | Yellow (fixed) | The user has acknowledged the event by buzzer silence |
|  | EARTH FAULT | Yellow (blinking) | Earth fault condition is present |
| | | Yellow (fixed) | The user has acknowledged the event by buzzer silence |
|  | SOUNDER FAULT / DISABLEMENT | Yellow (blinking) | Sounder fault condition is present |
| | | Yellow (fixed) | Sounders circuits are disabled |
|  | POWER SUPPLY FAULT | Yellow (blinking) | Mains fault |
| | | Yellow (fixed) | Batteries fault |
| | | Yellow (slow blinking 1sec On, 1sec Off) | Battery charger fault or Battery resistance fault condition is present |
|  | AUXILIARY POWER SUPPLY OUT FAULT | Yellow (blinking) | 24 VCC user fault condition is present |
| | | Yellow (fixed) | The user has acknowledged the event by buzzer silence |
|  | SYSTEM FAULT | Yellow (fixed) | System fault |

| STATUS ICON | CONDITION / CONTROL | COLOR | DESCRIPTION |
|---|---------------------|-------------------|------------------------------------|
|  | BUZZER MUTE | Yellow (blinking) | Buzzer is active |
| | | Yellow (fixed) | Buzzer has been muted |
|  | SOUNDERS STOP | Yellow (fixed) | Sounder outputs have been silenced |
|  | EVACUATE | Yellow (fixed) | Evacuation is activated |

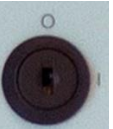
| PUSH BUTTON AND FUNCTIONAL KEY | DESCRIPTION | FUNCTION |
|---|------------------|---|
|  | RESET PANEL | Pressing the 'Reset Panel' button will reset the panel to return it to normal condition after an event |
|  | BUZZER MUTE | Pressing the 'Buzzer Mute' button or tapping on the touch screen, will silence the active panel buzzer |
|  | SILENCE SOUNDERS | Pressing the 'Silence Sounders' button will silence all Alarm sounders |
|  | EVACUATE | Pressing the 'Evacuate' button and later confirm the evacuation in the pop-up window, will start all the panel sounders output activation for the output configured for evacuation in the Cause and Effect I/O Matrix |
|  | LEVEL 2 KEY | In "O" position (default), Level 2 access is not granted. Inserting the key and turning it into "I" position, enables panels Level 2 Functions |

10 SYSTEM DEFAULT PASSWORD

PASSWORD ENTRY

When a function is protected by password, the below screens appear, indicating the Level required. Using the virtual keyboard, insert the password and confirm with enter:

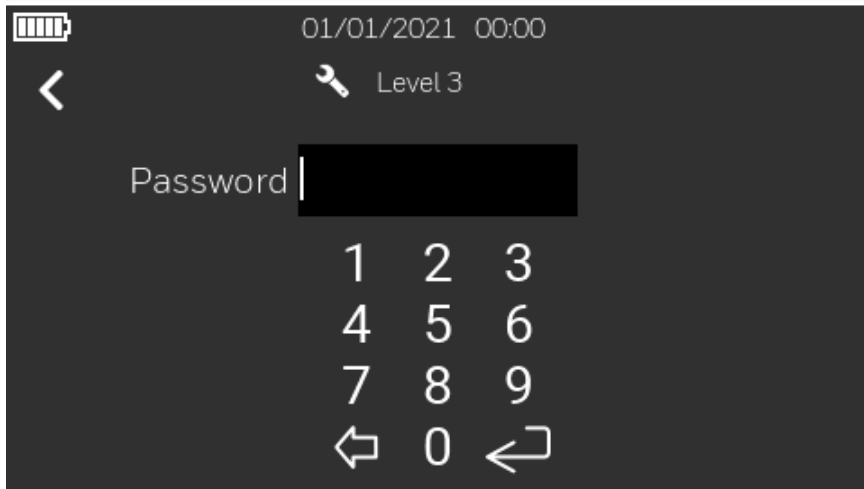

Fig. 20: Screen → Password Entry

| FUNCTION | EN 54 LEVEL | FACTORY DEFAULT PASSWORD |
|-------------------------------------|-------------|--------------------------|
| Alarm, disabled, and faults display | Level 1 | None |
| Alarm and faults recognition | Level 1 | None |
| Disabled Zone/Point display | Level 1 | None |
| Enable/Disable menu | Level 2 | 2222 |
| Test menu | Level 2 | 2222 |
| Utility menu | Level 2 | 2222 |
| Programming menu | Level 3 | 33333333 |

11 DISPLAY OVERVIEW

The status of the unit and its connected devices is shown on the display. The display is turned off on stand-by and it can be reactivated just by pressing anywhere on the display screen.

The battery charge indication and the current date/time are always shown on the upper part of each screen.



Fig. 21: Display when power up the unit

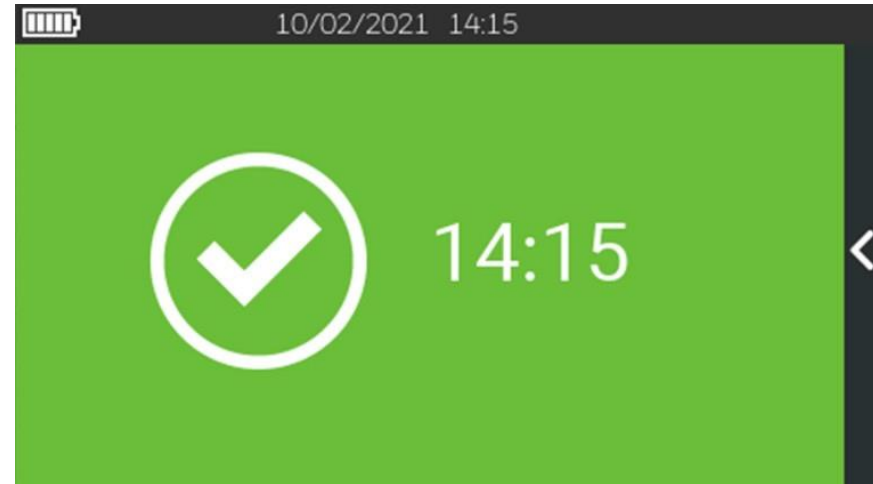
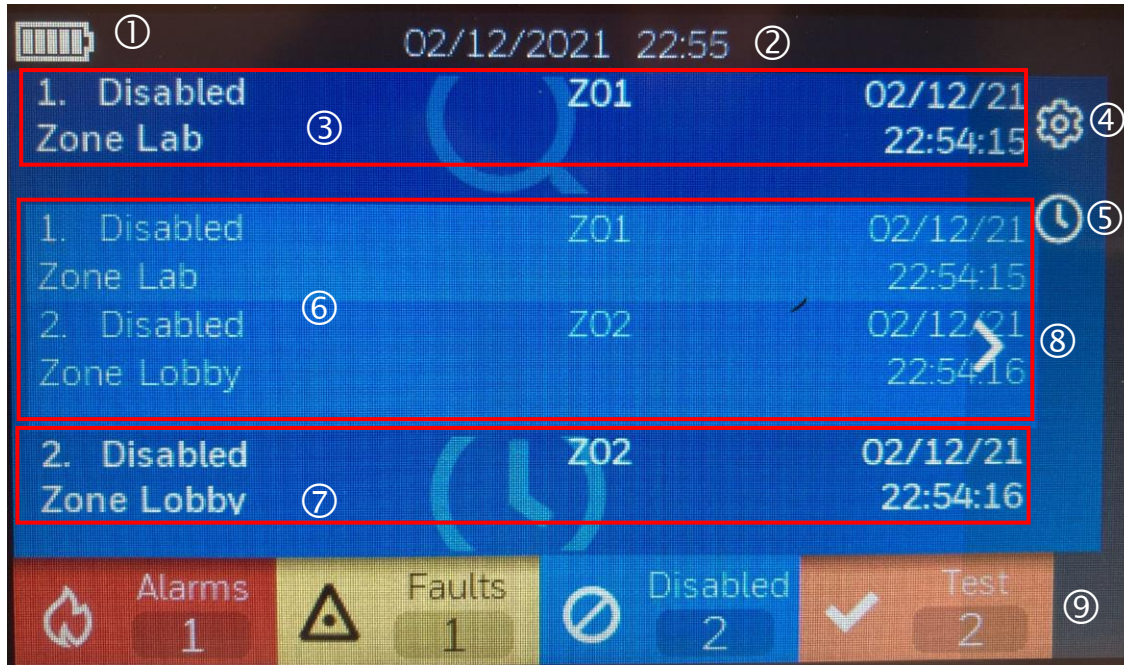

Fig. 22: Display in quiescent state

11.1 Display indications and buttons



| | |
|---|--------------------------|
| ① | Battery Charge Indicator |
| ② | Current Date & Time |
| ③ | Event Detail |
| ④ | Configuration |
| ⑤ | Delay Override |
| ⑥ | Event List |
| ⑦ | Last Event |
| ⑧ | Menu / Function Arrow |
| ⑨ | Event counters |

Fig. 23: Display indications and buttons

The display change color based on the system condition, or the events visualized:

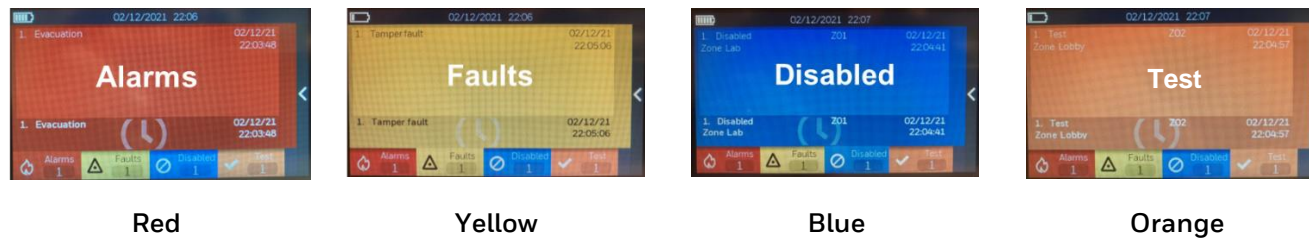

12 CONFIGURATION MENU

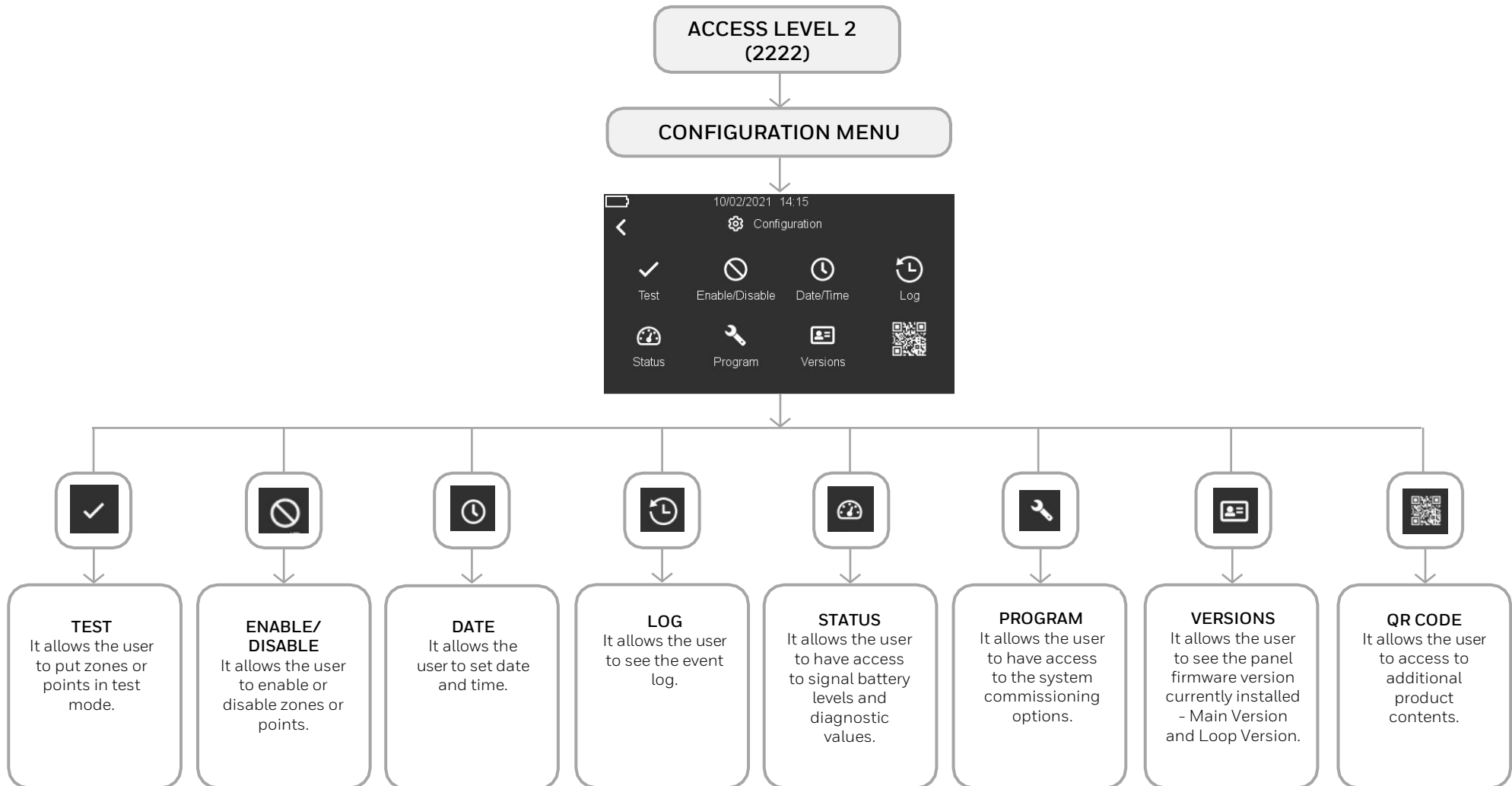

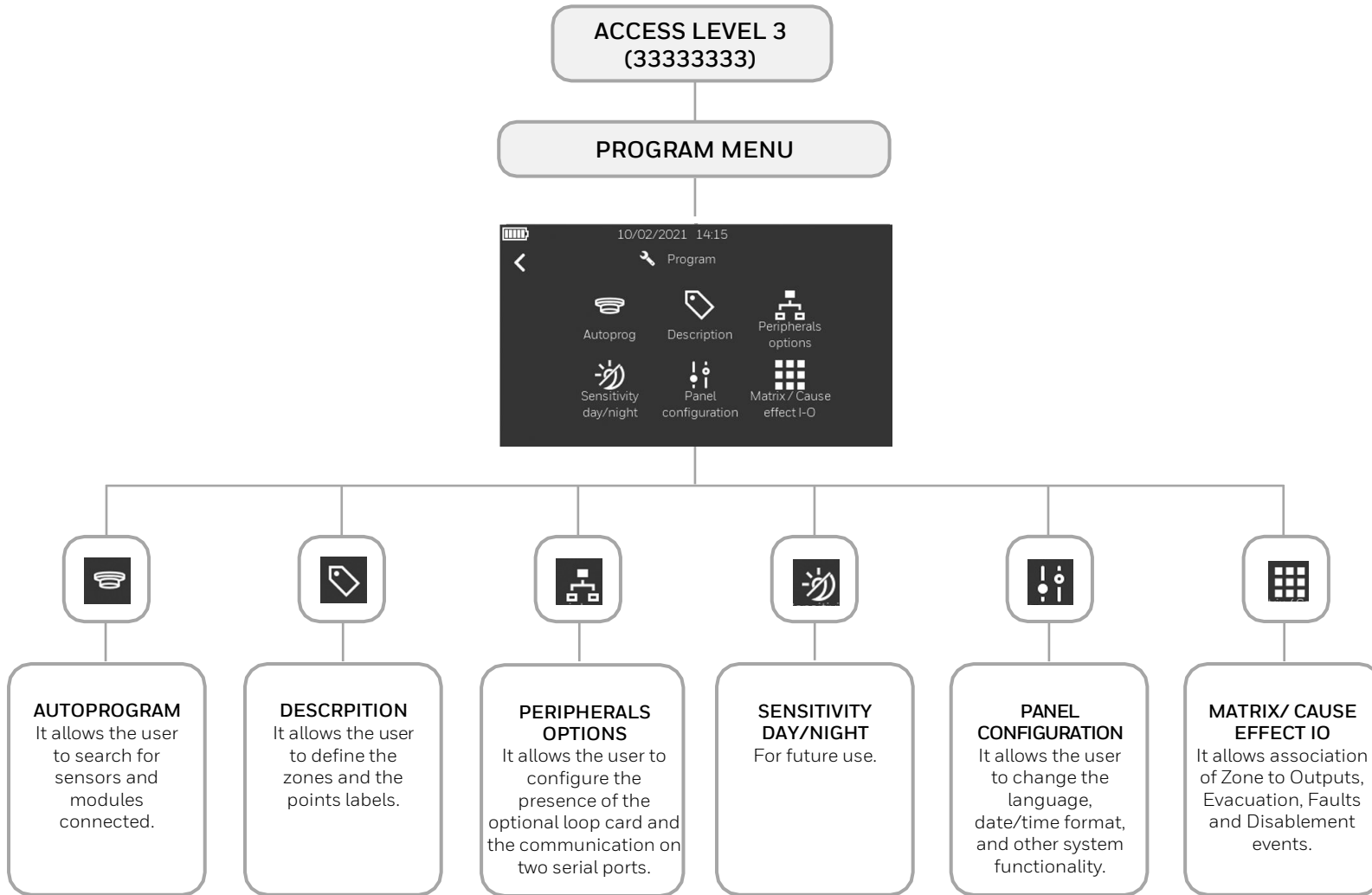

13 PROGRAM MENU

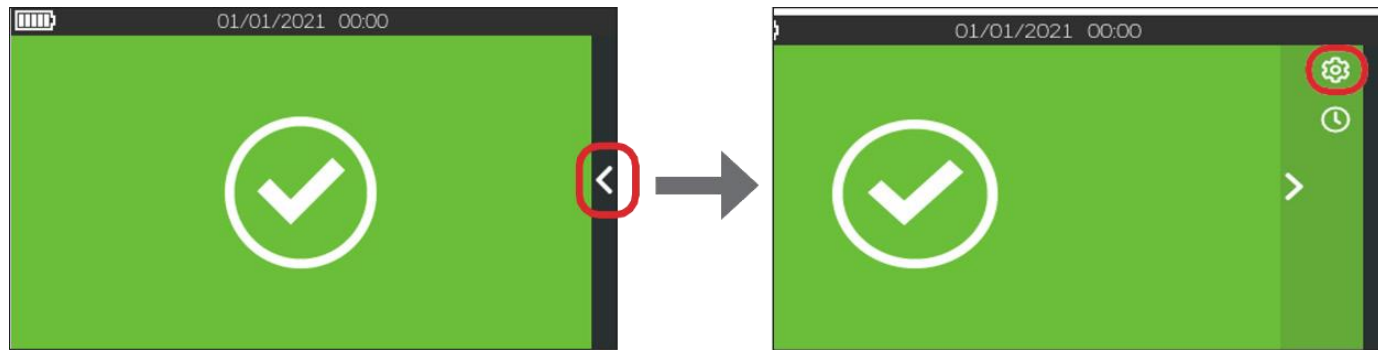

13.1 Configuration – access to menu

After having connected the devices and the power supply, activate it turning on the control unit and then connecting the batteries as shown in the previous setup and connection paragraph. When switched on, the programming of the panel must be carried out to allow detecting the connected devices.



1. On the touch screen display press the arrow  on the right and then press the gear icon  at the topright:

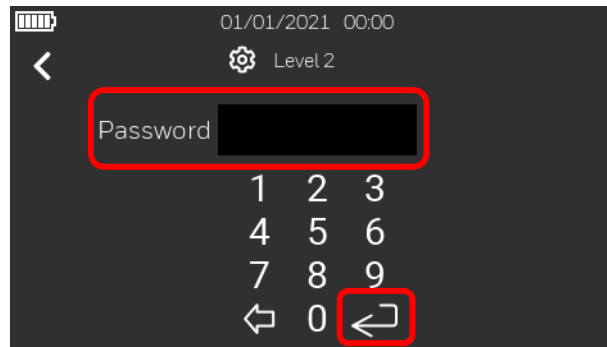

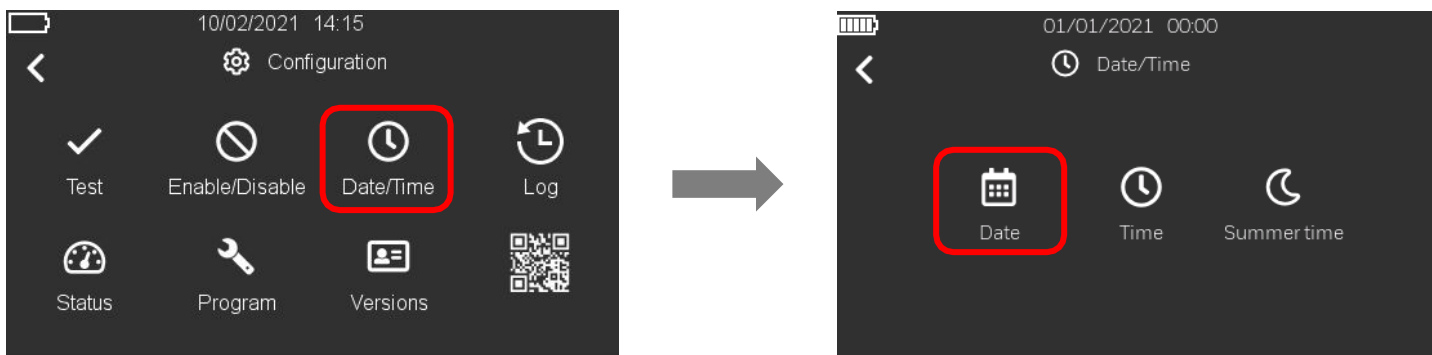

2. The page below will be displayed. Insert the password of level 2 (2222) and press the "enter" key to confirm the password.

13.2 Configuration - Date and Time setting

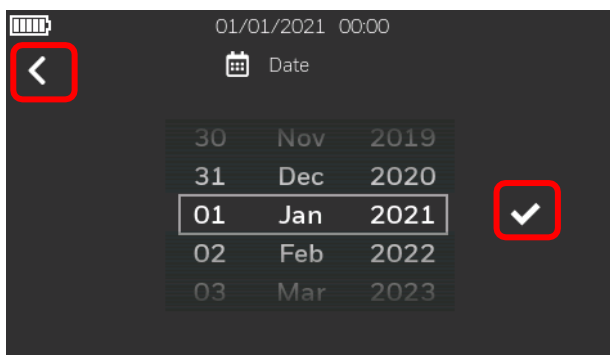

1. After having pressed the "Date/Time" icon  in the "Configuration" menu, press the "Date" icon  to set the current date.



2. Insert the date and then press the check mark  to save the setting. Press the back arrow  to go back the previous screen

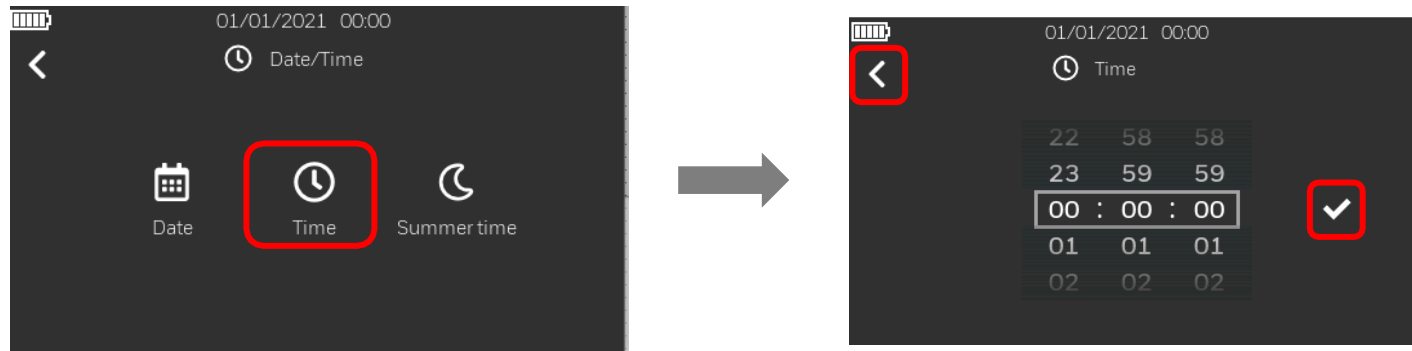

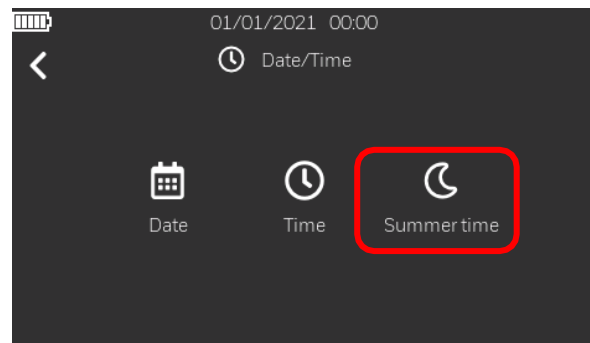

3. Then press "Time" icon  to set the time and the check mark  to save the setting. Press the back arrow  to go back to the previous screen.



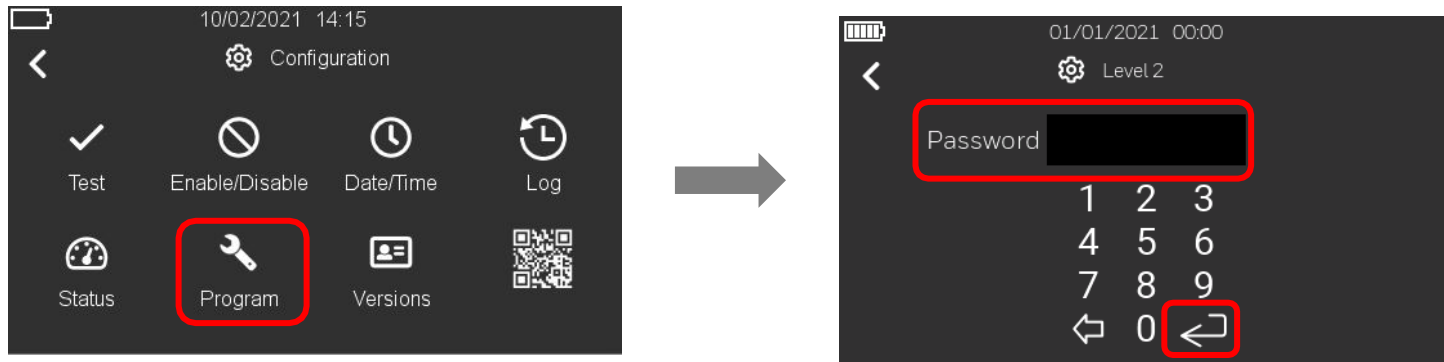

4. By pressing the following icon , you can set the "Summertime" (**future implementation**).

13.3 Configuration – Panel configuration

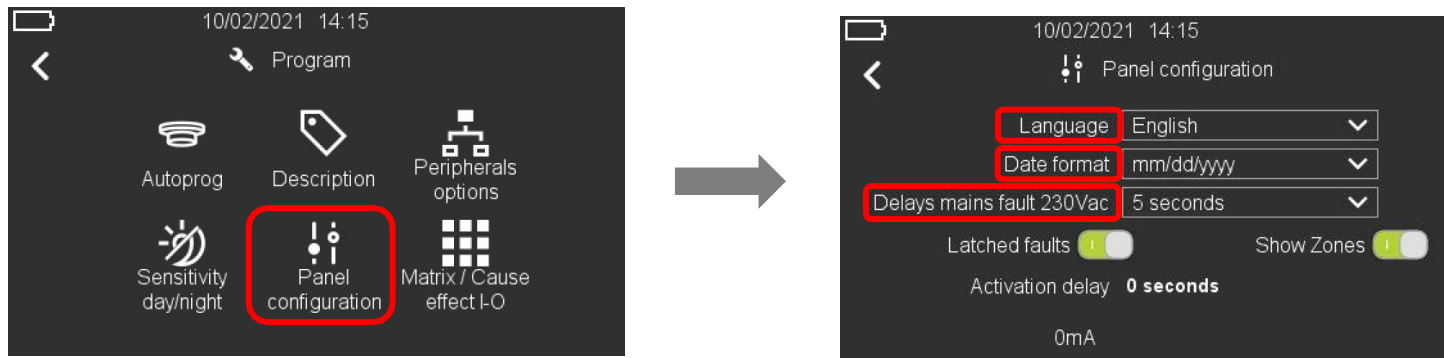

1. Press on the “Program” icon  and insert the password of level 3 (33333333). Press the "enter" key to confirm the password. Press on the back arrow  to go back.



2. Press on "Panel Configuration" icon and insert the language of the system, the date and the time format and the delays mains fault value as shown in the screen on the lower right. Data are selected and chosen by pressing on the down arrow .

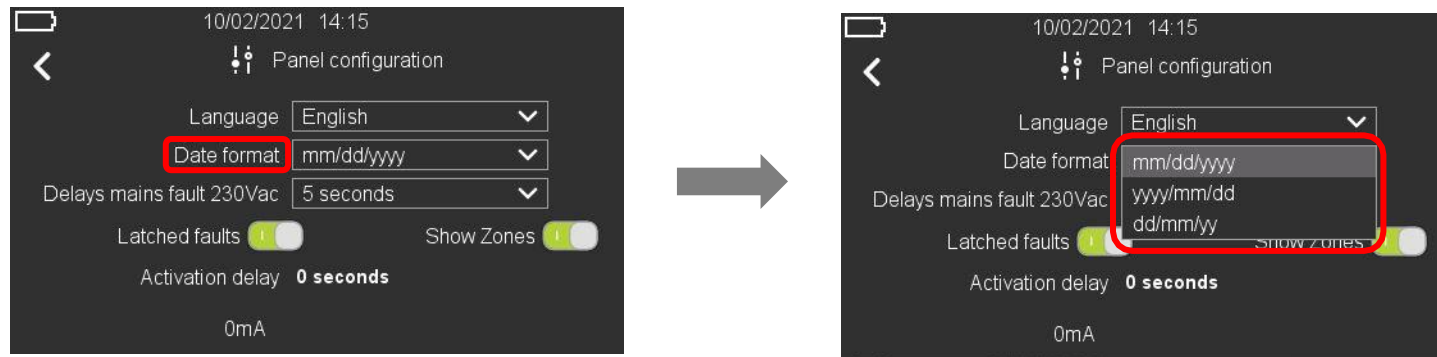

- Pressing the arrow down on Date Format field, you can change the date format between mm/dd/yyyy, yyyy/mm/dd or dd/mm/yyyy. Press on the back arrow  to go back.

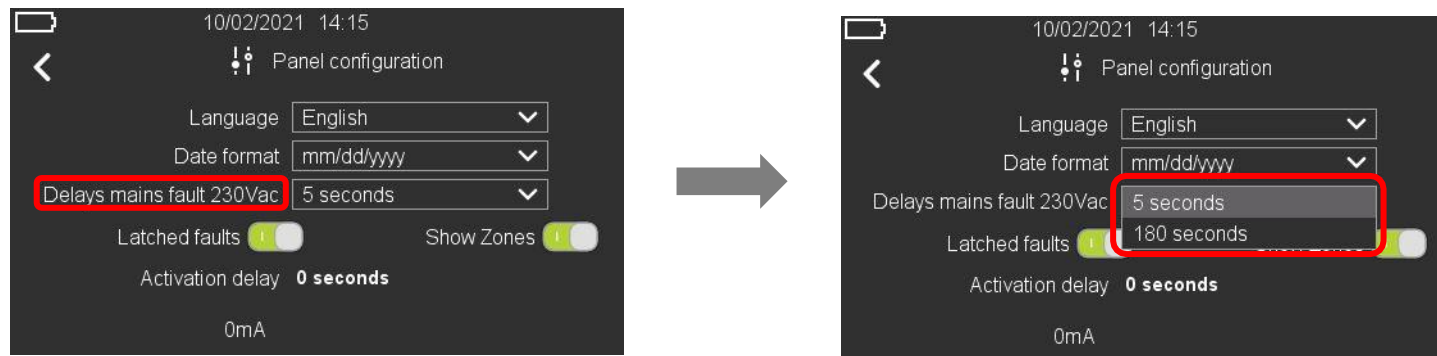

- Pressing the arrow down on Delays mains fault 230 Vac field, you can change the mains fault delay time from 5 second (default) to 180 seconds. Press on the back arrow  to go back.

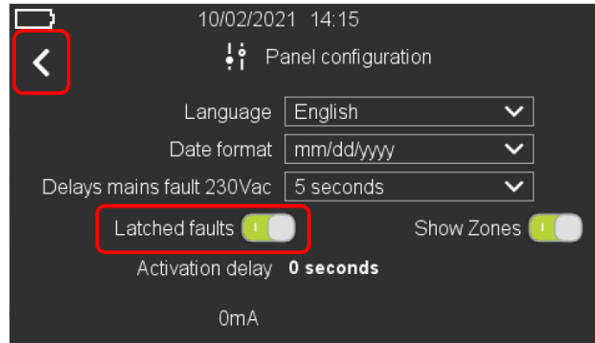

5. Latched Faults option, enable / disable all faults to works in latched mode or unlatched mode, so that when the fault condition is restored, the related event is automatically reset. Press on the back arrow  to go back to the previous screen.

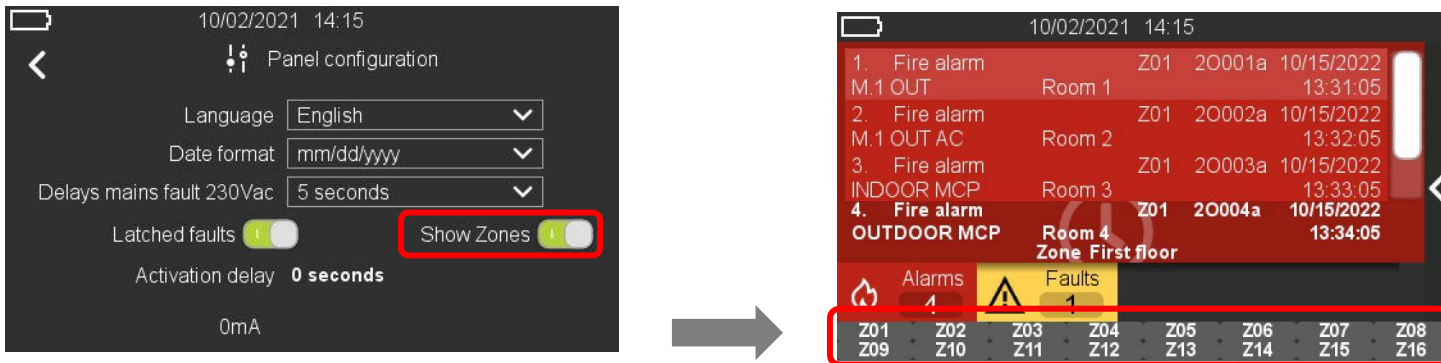

6. Show zones option, enable / disable Virtual Zone Led Indicators on the main panel screen as shown on the picture at right. Each Zone is represented by a Virtual LED that change color based on the Zone status: Red = Alarm, Yellow = Fault, Blue = Disablement, Orange = Test. Press on the back arrow  to go back to the previous screen.

13.4 Configuration – Peripherals option

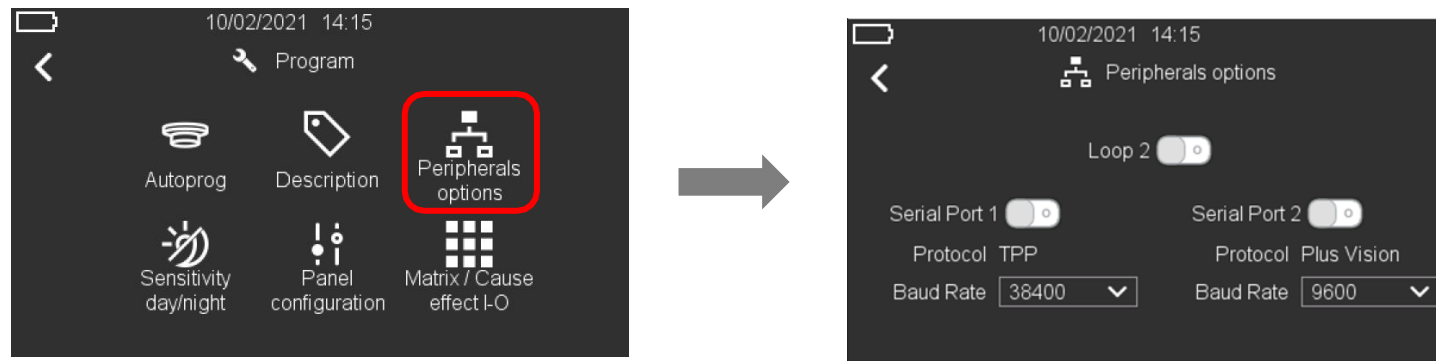

1. Select “Peripherals option”. You can configure the presence of the optional loop card. From this menu, you can also configure the communication for the two serial ports with Third Party (TPP) and Plus Vision protocols respectively, along with the baud rate for each serial port.

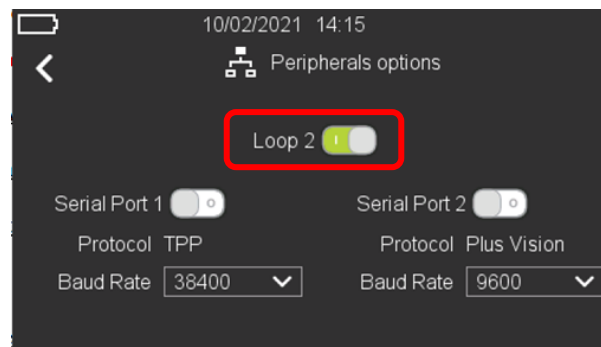

2. Click on the empty circle near the Loop Card 2 to enable the second loop. Press the back arrow  to go back to the main screen.

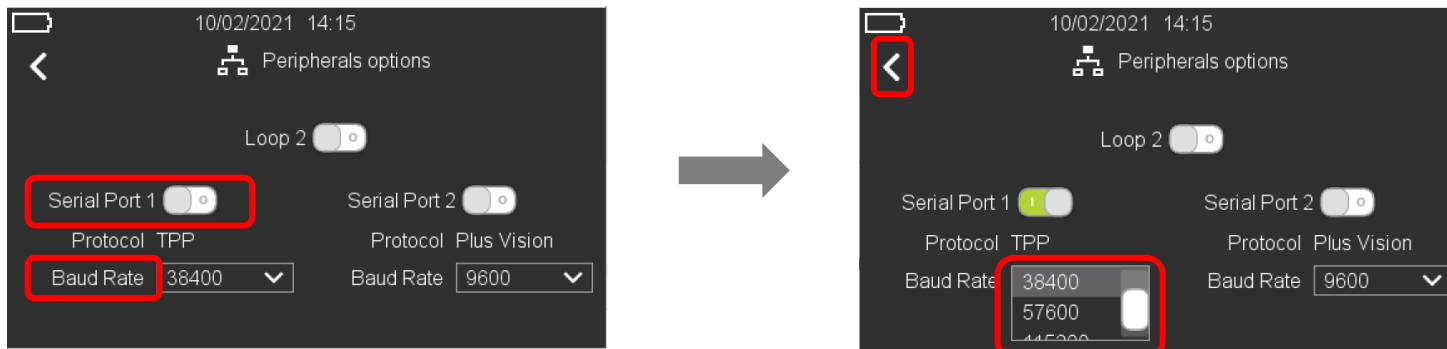

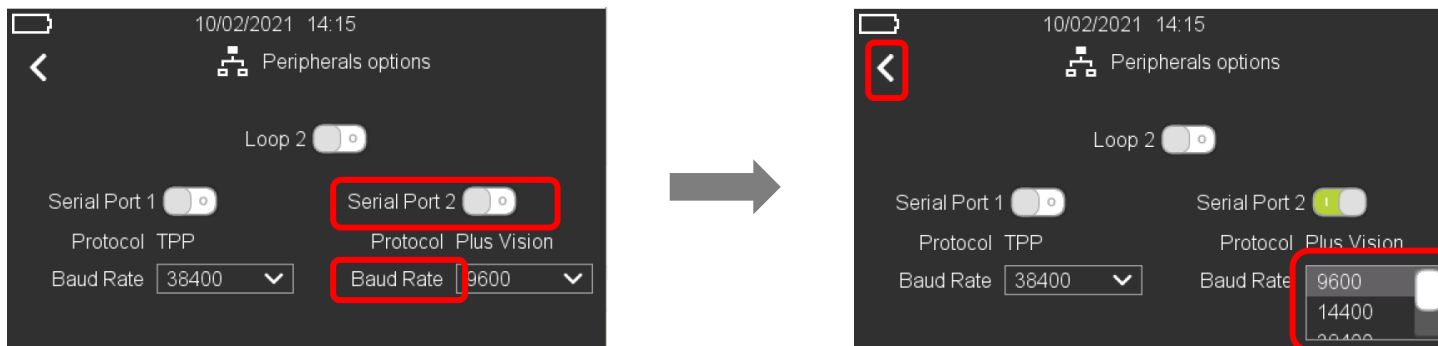

- Click on the empty circle near Serial Port 1 to enable the port for Third Party (TPP) protocol communication at a default baud rate of 38400. Pressing the arrow down on the Baud Rate field, you can change the baud rate from the list: 9600, 14400, 19200, 38400, 57600 and 115200. Press the back arrow  to go back to the main screen.

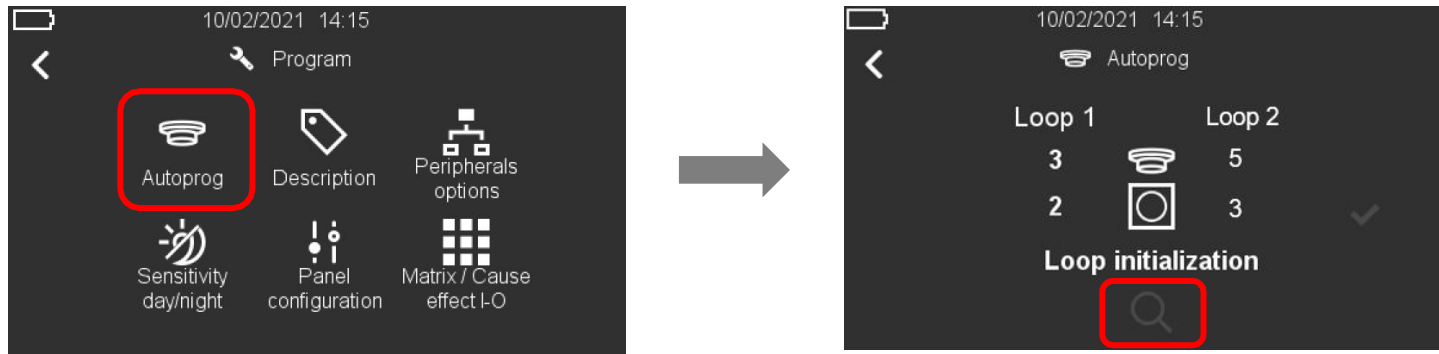

- Click on the empty circle near Serial Port 2 to enable the port for Plus Vision protocol communication at a default baud rate of 9600. Pressing the arrow down on Baud Rate field, you can change the baud rate from the list: 9600, 14400, 19200, 38400, 57600 and 115200. Press the back arrow  to go back to the main screen.

13.5 Configuration – Autoprogram





Select “Autoprogram” then press on the magnifying lens  to commence the searching of sensors and modules connected on the loop(s). After the scan is complete, a dialog box is displayed to start the output test. Click on the check mark to run it. This step is mandatory for proper operation of the loop.

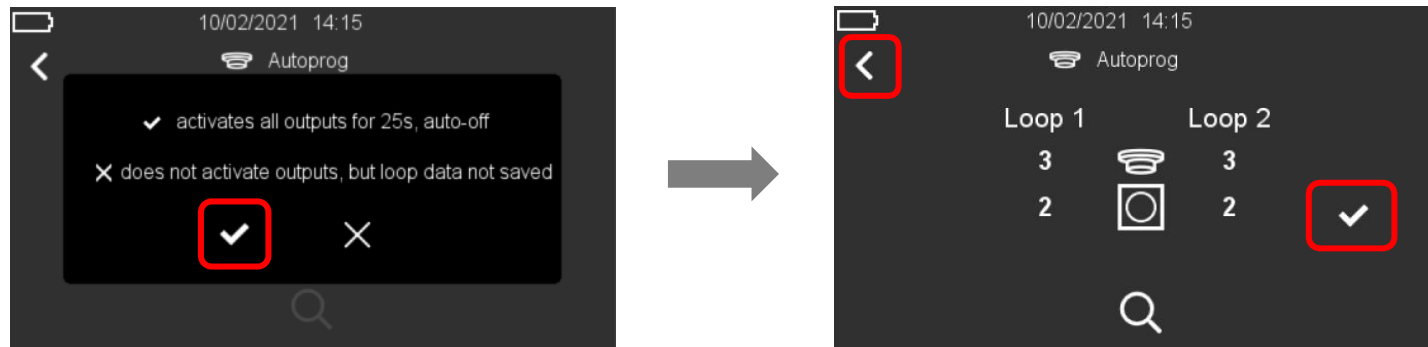

Please note: By selecting the check mark option in the below dialog box, will activate all connected loop sounders for approximately 25 seconds. If the ‘X’ is selected, the outputs on the loop(s) will not activate, but the auto-learn data will be lost, and you must restart the auto-learn process. The output test is mandatory and **MUST** be initiated after each auto-learn.



Once it is complete, click on the check mark  again. Press the back arrow  to go back to the main screen.





Loop initialization

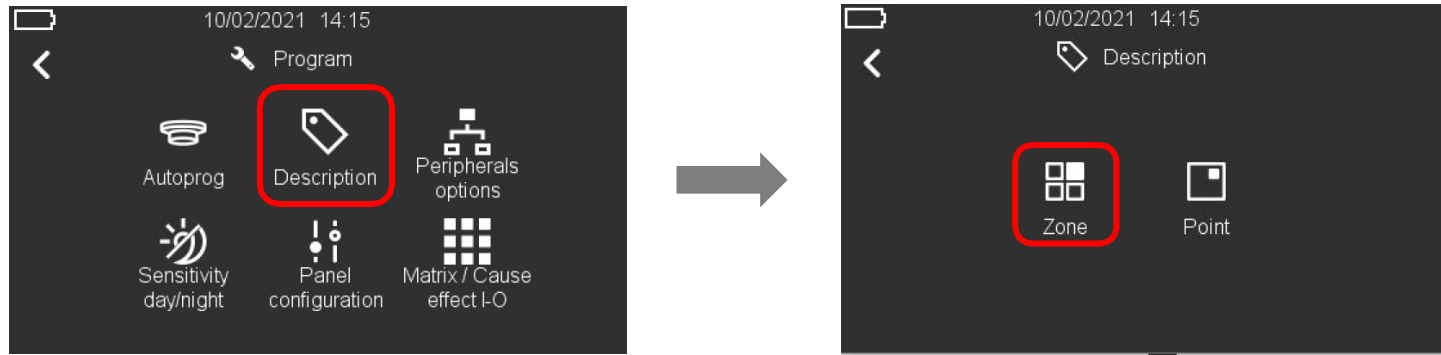

If loop initialization is in progress (e. g. at power on), Autoprogram may be blocked. Therefore, the search icon may be greyed out and the message "Loop initialization" is shown to indicate that the user must wait until initialization is done. Once completed, the message disappears, and the search icon is enabled again.

13.6 Configuration – Description



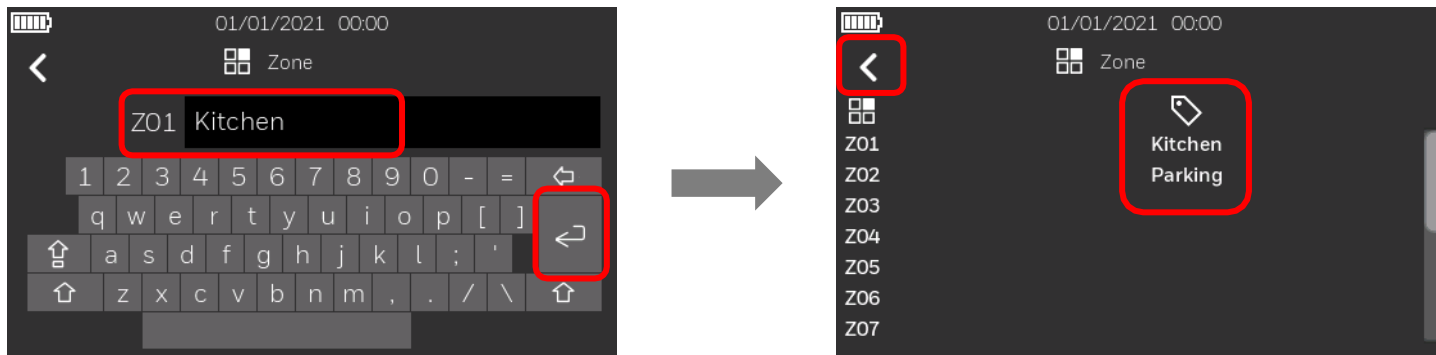

1. From the "Program menu", press the "Description" icon ; the "Zone" icon  allows you to define the zones, the "Point" icon  allows you to define the points.

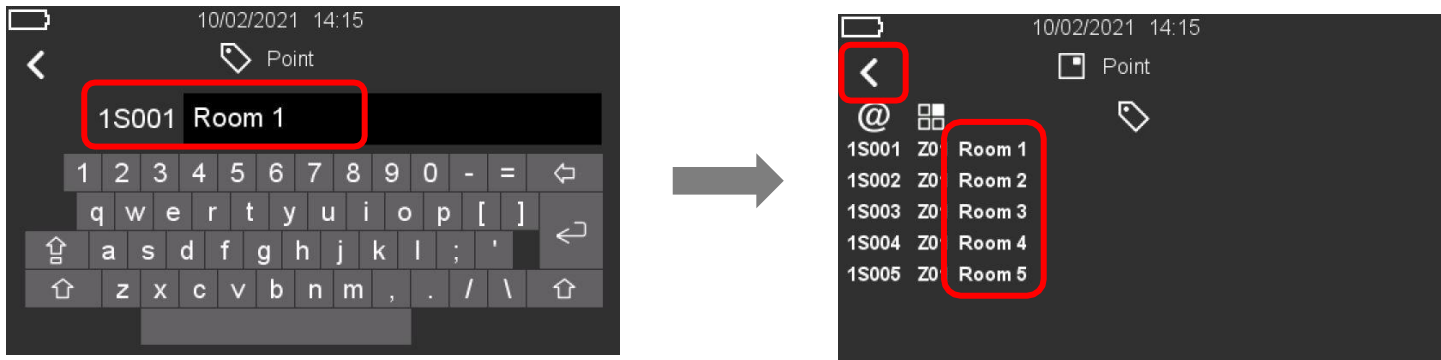

2. To define a Zone, press on the icon , then press at the right side of the zone number (e.g. Z01), below the icon  and type the name of the zone. A QWERTY keyboard appears to enter the description. It is possible to insert up to 20 characters. Press the "enter" key to save and confirm the zone description. Press the back arrow  to go back to the previous screen.



3. To define a Point, press on the icon , then press at the right side of the device number (e.g. 1S001) below the icon  and type the name of the device. It is possible to insert up to 20 characters. Press the "enter" key to save and confirm the point description. Press the back arrow  to go back to the previous screen.

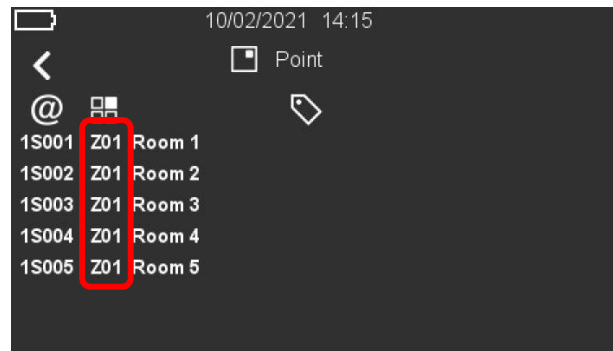

4. Press on the zone number to change the Zone to which the device is linked.



This icon indicates whether the device is a Module (M) or a Sensor (S).



This icon indicates the zone to which the Sensor is linked.

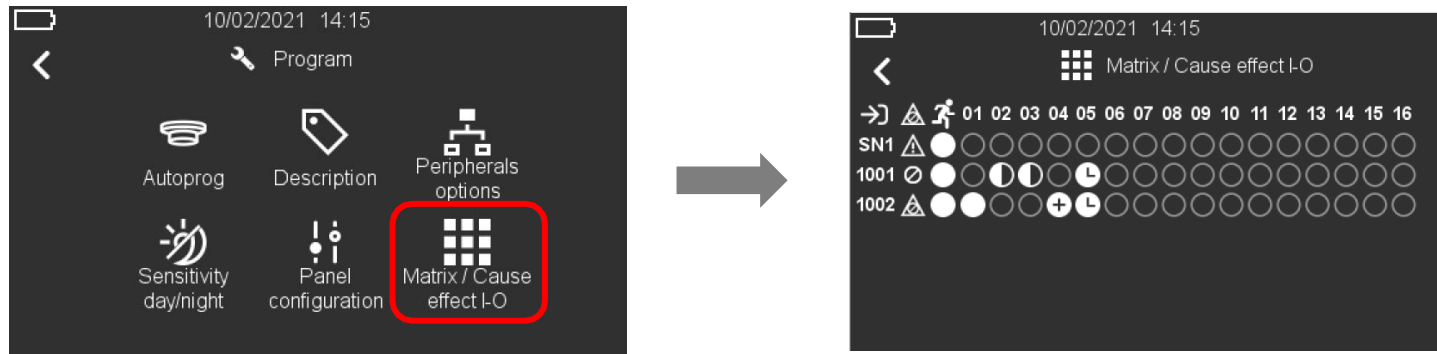

13.7 Configuration – Matrix / Cause and effect I-O



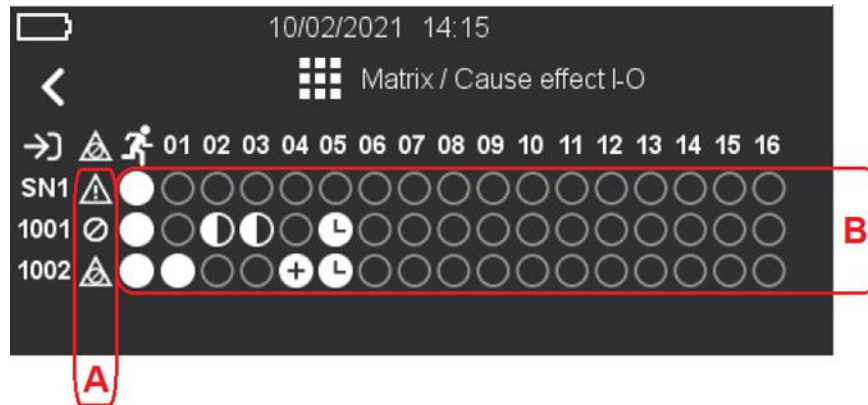



In this menu, you can associate the Zones, General Fault/Disablement events and Evacuation to the panel sounders and to the addressable outputs. The association happens simply clicking on the dot that crosses the Zone/Function inputs and the outputs.



- A) Icons relation to General Panel Fault and Disablements. Users can associate the panel fault & disablement conditions to the output devices.
- B) Icons relation to Evacuation button & Zone activation. Users can associate Evacuation & Zone activations to each output devices.

| A) Icons for General Fault & Disablement | |
|---|--|
|  | Activates output with General Panel Fault. Any Zone, Device or Panel Fault will activate the associated output. |
|  | Activates output with General Panel Disablement. Any Zone, Device or Panel Disablement will activate the associated output. |
|  | Activates output with General Panel Fault or Disablement. Any Zone, Device or Panel Fault, or Disablement will activate the associated output |

| B) Icons for Zones and Evacuation button | |
|---|---|
|  | Empty Dot - The Input and the output ARE NOT associated. No action will occur during an Alarm event. |
|  | Full Dot - The Input and the output ARE associated. The output will activate immediately in the event of an Alarm. |
|  | Half Dot - At least two Zones with the same selection Half Dot are required to be in Alarm to activate the relevant output. (Double consent/Knock Cross-Zone) |
|  | Plus Dot - At least two devices related to the same Zone associated to the output must be in alarm to activate the relevant output (Double consent/Knock single Zone). |
|  | Clock Dot - Indicates that the output will be activated once the countdown of the delay time configured into the Panel Configuration menu is finished. The Delay Override option is automatically enabled on the main screen menu, and you can override the delay time at any time pressing the button. |

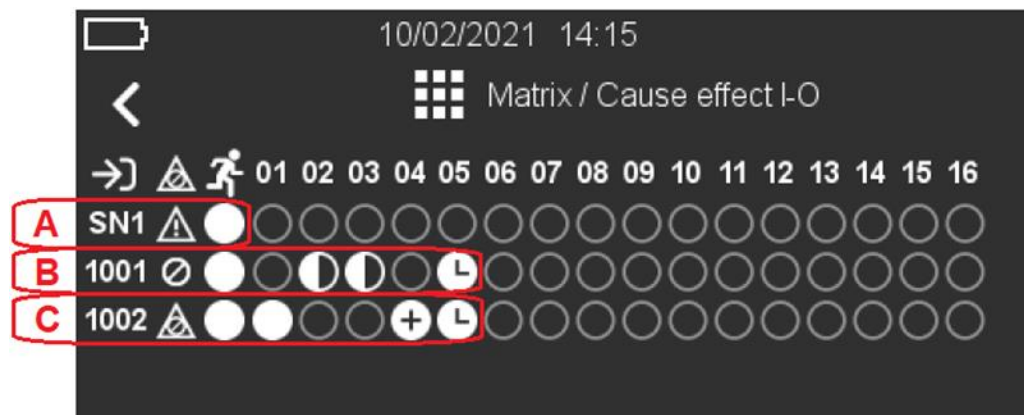

In the example shown, the I/O associations are:

- A Sounder Circuit 1
 - Activates with General Fault
 - Activates with Evacuation Button Press
- B Output Module 001
 - Activates with General Disablement
 - Activates with Evacuation Button Press
 - Activates with coincidence (two devices in alarm) cross Zones 2 & 3
 - Activates after delay with Zone 5 Alarm
- C Output Module 002
 - Activates with General Disablement or General Fault
 - Activates with Evacuation Button Press
 - Activates immediately with Zone 1 Alarm
 - Activates with Point coincidence (two devices in alarm) from Zones 4
 - Activates after delay with Zone 5 Alarm

13.8 Configuration – Activation delay



1. Follow the steps to enter in "Panel Configuration" menu.
2. Click on the right of "Activation delay" option, then assigned the output delay activation from 0 (immediate activation) to 600 seconds and confirm with enter.

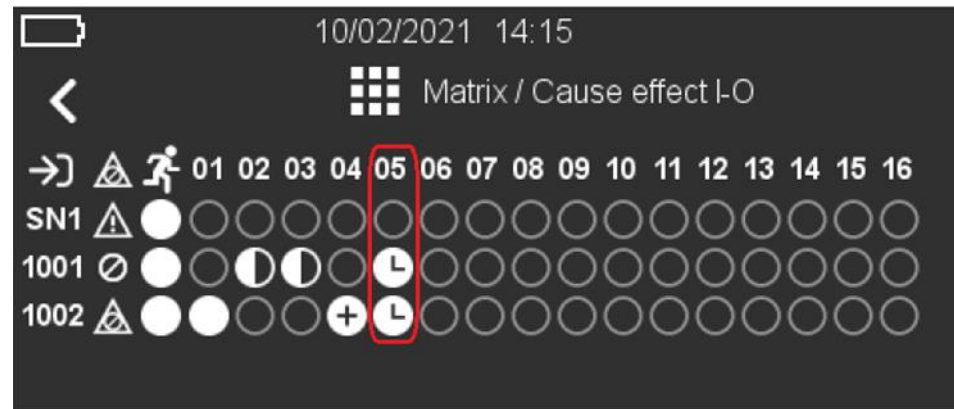

3. To enable the Output to be activated with the delay set, in the Cause and Effect I/O Matrix must be set the icon to the corresponded Output.

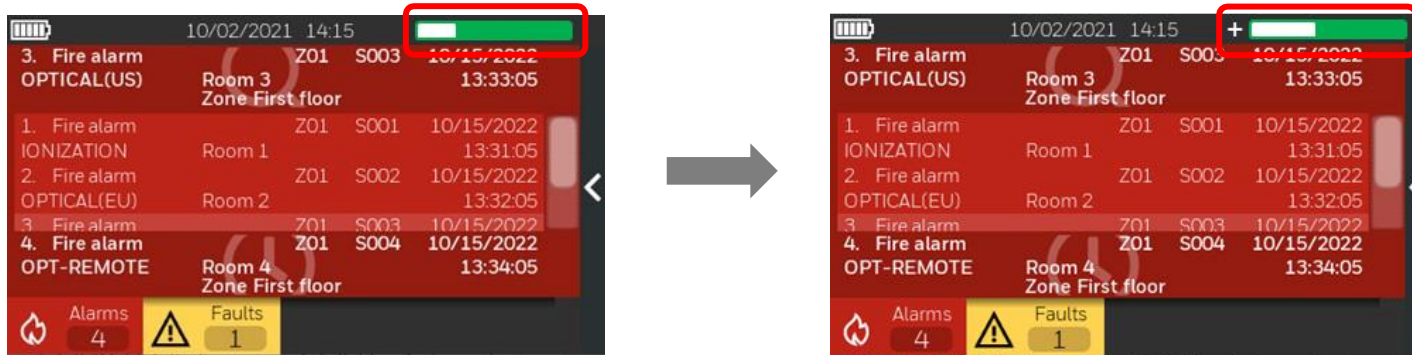



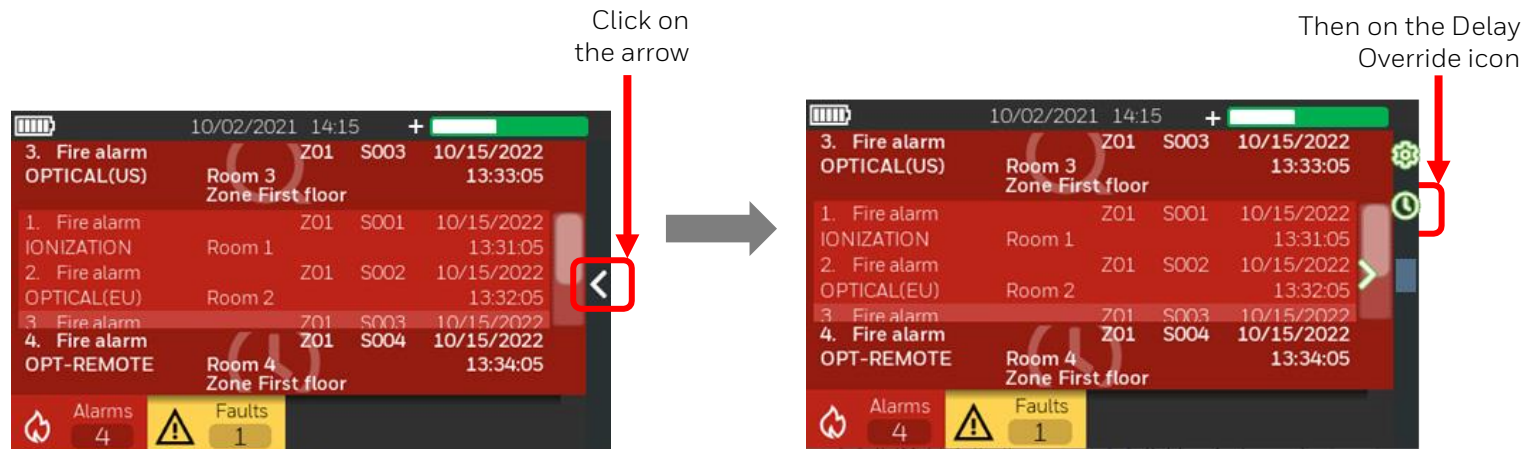

4. When a delay is active, a timeline appears on the main screen to show the delay progresses. If another Zone set to works with the delay goes into alarm, a '+' mark appears near the delay bar, indicating that another countdown is started.



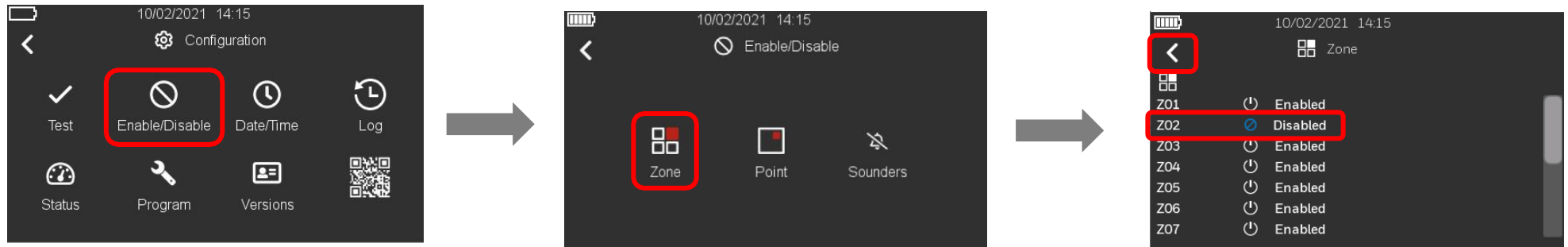



5. The Delay Override Option is now enabled on the main display, allowing the operator to activate the outputs configured for delay in the Cause and Effect I/O Matrix before the countdown is finished.

14 OPERATION - ENABLE / DISABLE ZONE AND POINT

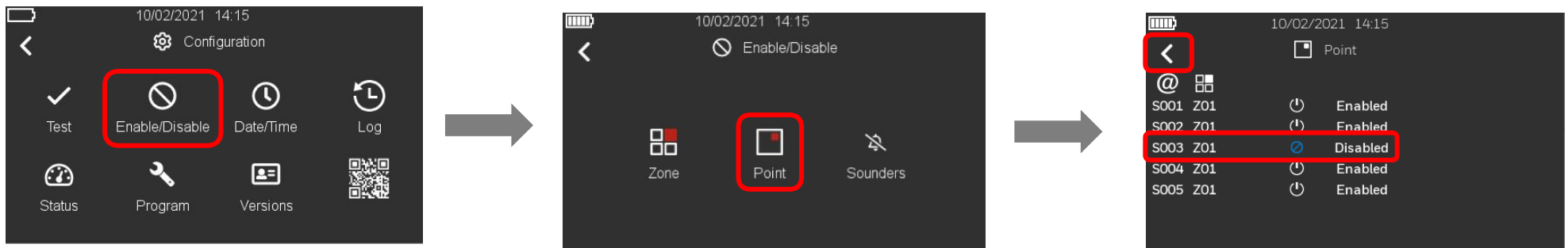







1. Follow the steps to enter in "Configuration" menu, select "Enable/Disable" icon to display the Zone, Point and Sounders options, then select Zone to view the list and then click on the icon  near the Zone you would like to Disable to change its status. The Disabled icon  appears near the selected Zone and the status label will be updated (Enabled/Disabled), in this example Z02. Press the back arrow  to go back to the main screen.

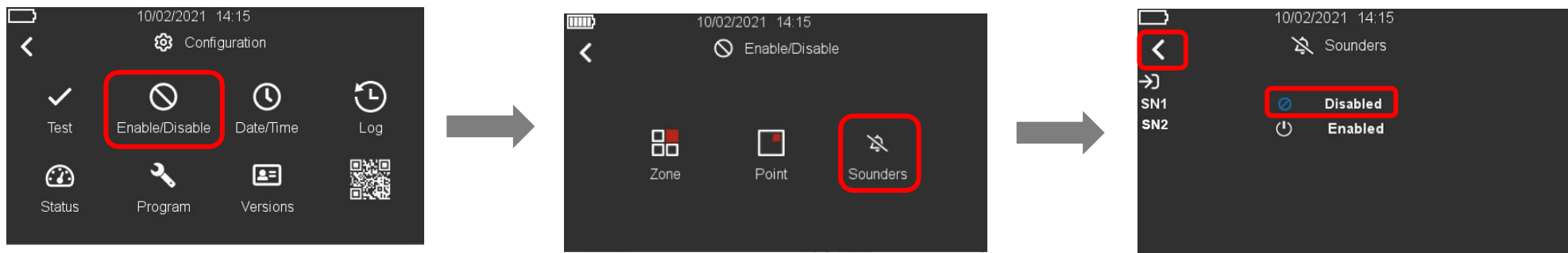

2. Same procedures apply to Disable a Point:
3. To Enable a Zone or Point again follow the same steps: clicking on the related Disabled icon  the Zone or Point. The icon will change displaying the Enabled icon , and status label will be updated to 'Enabled'. Press the back arrow  to go back to the main screen.

15 OPERATION - ENABLE / DISABLE SOUNDERS



1. Follow the steps to enter in "Configuration" menu, select "Enable/Disable" icon to display the Zone, Point and Sounders options, then select Sounders to view the list and then click on the icon  near the Sounder to Disable it. The Disabled icon  appears near the selected Sounder and the status label will be updated, in this example SN1. Press the back arrow  to go back to the main screen.
2. To Enable a Sounder again, follow the same steps: clicking on the related Disabled icon  for the Sounder. The icon will change displaying the Enabled icon . Press the back arrow  to go back to the main screen.

16 SYSTEM STATUS

16.1 System status – Wireless devices (this functionality will be available on next Firmware release)

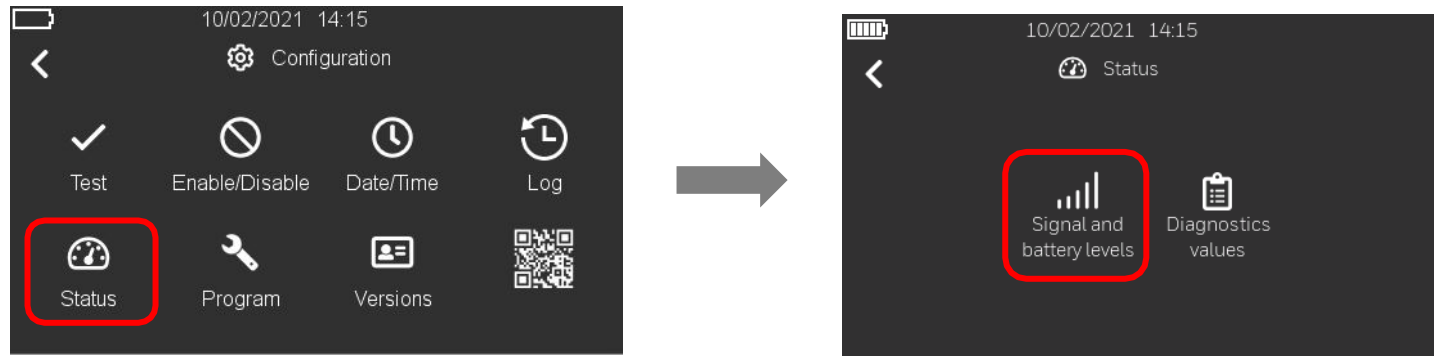

1. Follow the steps to enter in “Configuration” menu, then select “Status” then press “Signal and battery levels”.

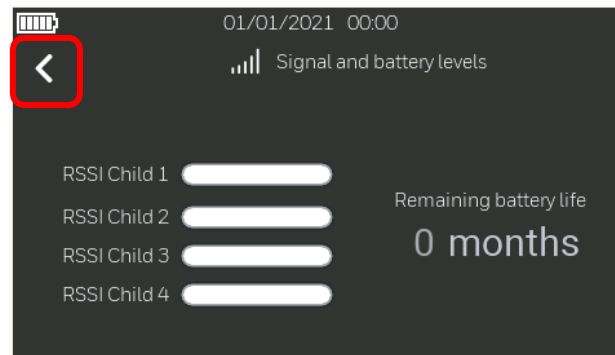

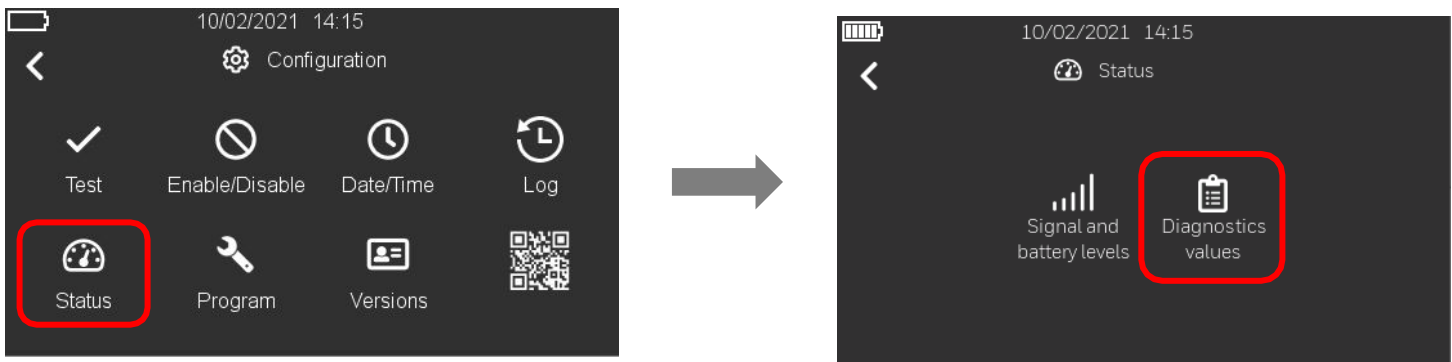

2. Here you can see the status of AGILE battery life and the remaining lifetime. Press the back arrow  to go back to the main screen.

16.2 System status – Panel Diagnostic values

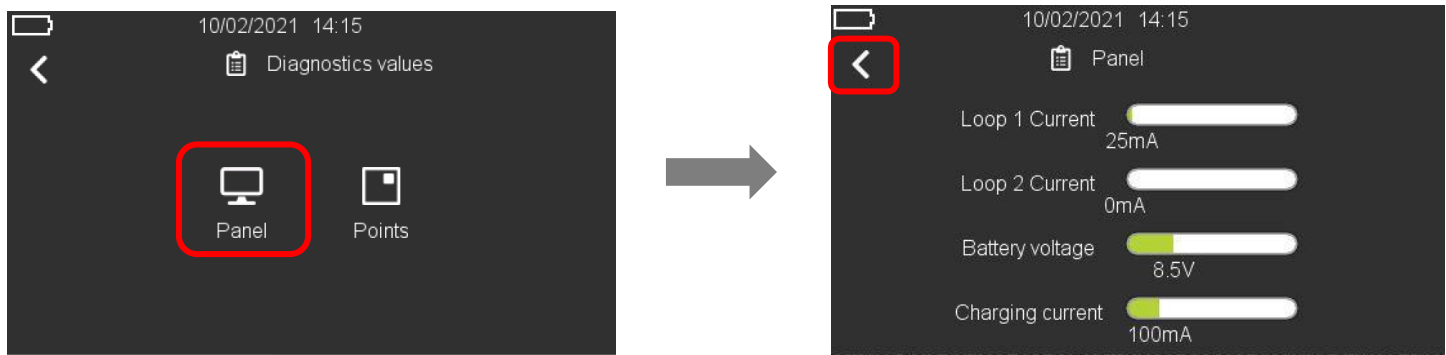

1. Follow the steps to enter in “Configuration” menu, then select “Status” then press “Diagnostic values”.





2. Select “Panel” to see current system status: loop current absorbed by the wired field devices, the battery voltage, and the charging current. Press the back arrow  to go back to the main screen.

16.3 System status – Points Diagnostic values

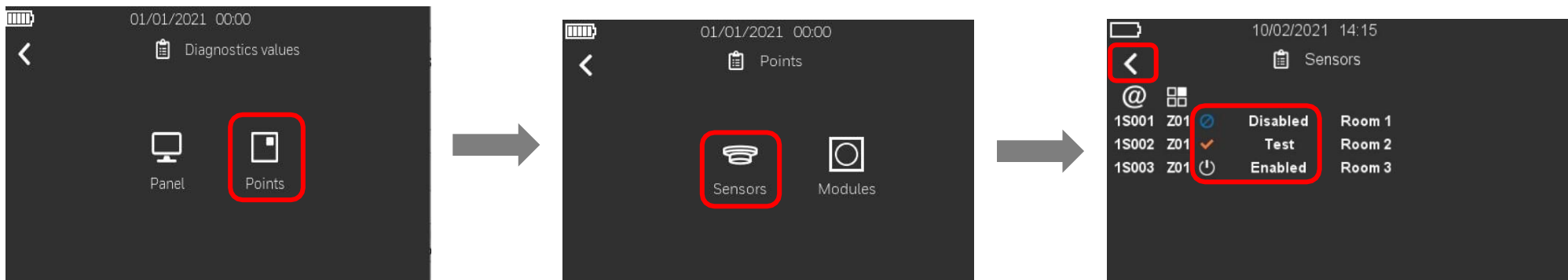

1. Follow the steps to enter in “Configuration” menu, select “Status” then press “Diagnostic values”.



2. Select “Points” to move to the next screen where you can select “Sensors” or “Modules” list. In this example, Sensors are selected to see the status represented by the relevant icons. Press the back arrow  to go back to the main screen.

17 HISTORY LOG

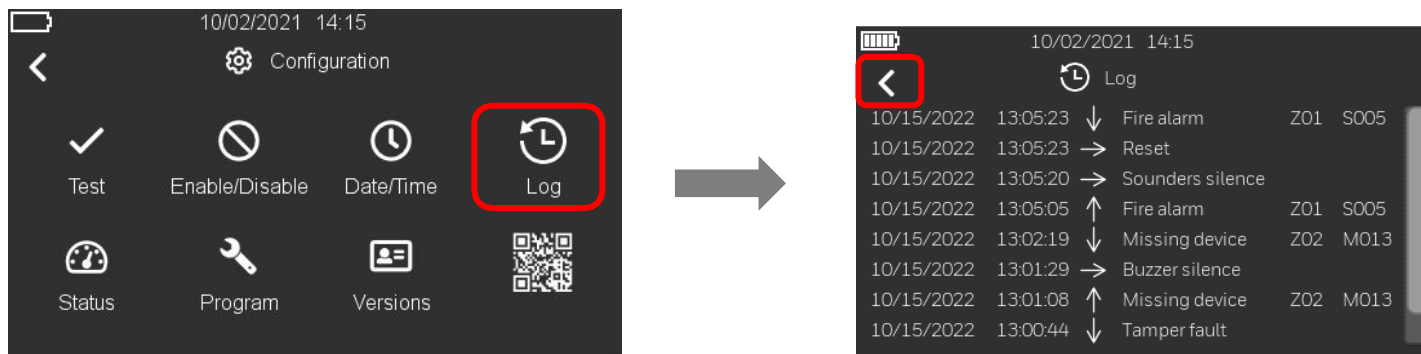

1. Follow the steps to enter in “Configuration” menu, then select “Log”.
2. The events are shared in sequence, the latest is on top and the oldest is on the bottom of the list. Are shown date and time of the events, the type of the events, the Zone number and the related device address. Are also shown the commands released from the panel.

The arrows indicate:

- ↑ an event has started
- ↓ an event is finished
- → a command from the panel was released.

3. Press the back arrow  to go back to the main screen.

18 VERSIONS

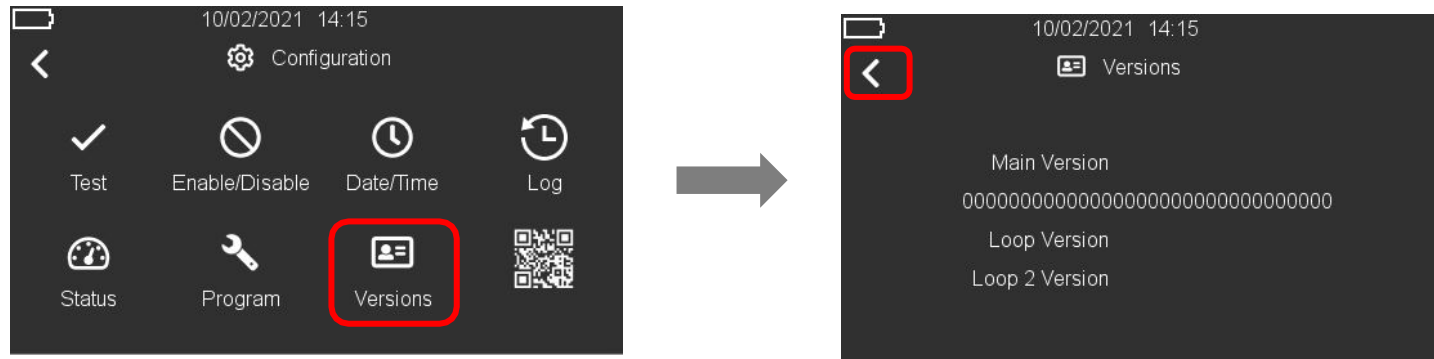



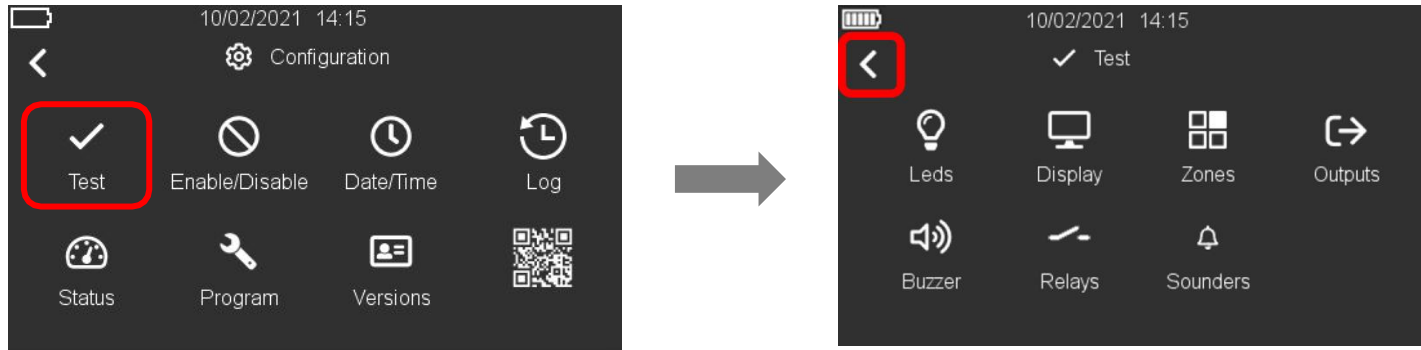

1. Follow the steps to enter “Configuration” menu, then select “Version”.
2. Displayed are the firmware versions of the main CPU, Loop 1, and Loop 2 (if installed), along with a 32-digit unique serial number of the panel.
3. Press the back arrow  to go back to the main screen.

19 SYSTEM TEST

19.1 System test - User interface and relay



1. Follow the steps to enter in “Configuration” menu and select “Test” to access to the related options.
2. Selecting the following icons, you will have:

| | | |
|---|----------------|--|
|  | LED | All front panel LED become steady for 3 seconds and then automatically come back to the previous condition |
|  | DISPLAY | The display change color dynamically and then come back to the menu |
|  | BUZZER | The buzzer sounds for 3 seconds and then turn off automatically |
|  | RELAY | The alarm and trouble relays get activated for 3 seconds and then gets deactivated automatically |





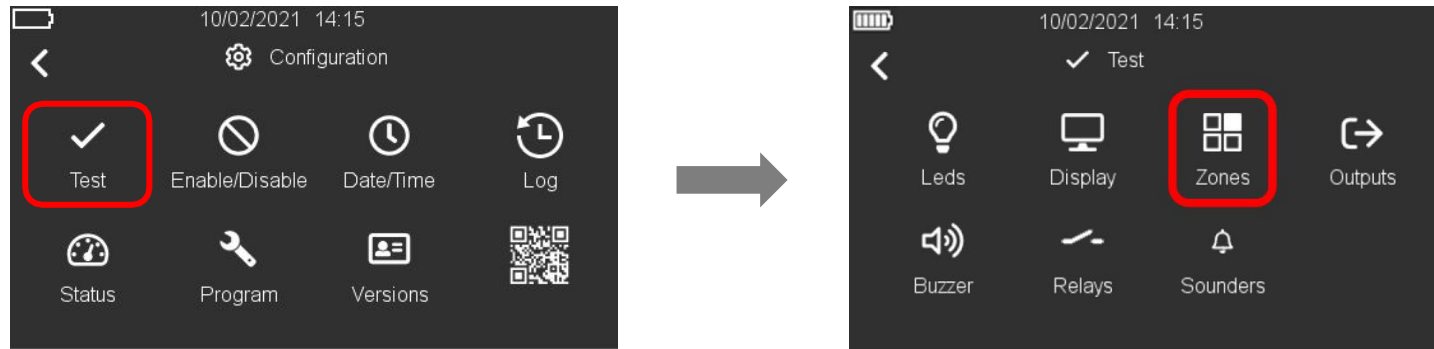

3. Press the back arrow  to go back t1o the main screen.

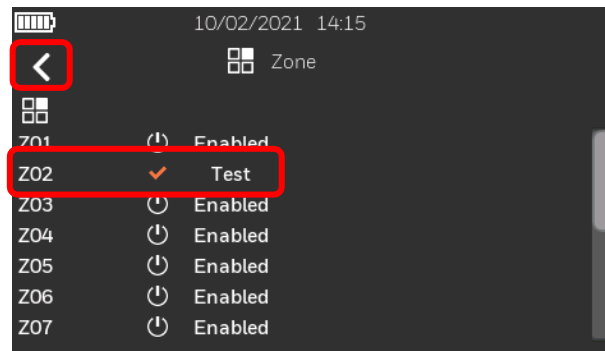
19.2 System test – Zones



1. Follow the steps to enter in “Configuration” menu, select “Test” to access to the related options, then select “Zones” icon to view the Zone list.



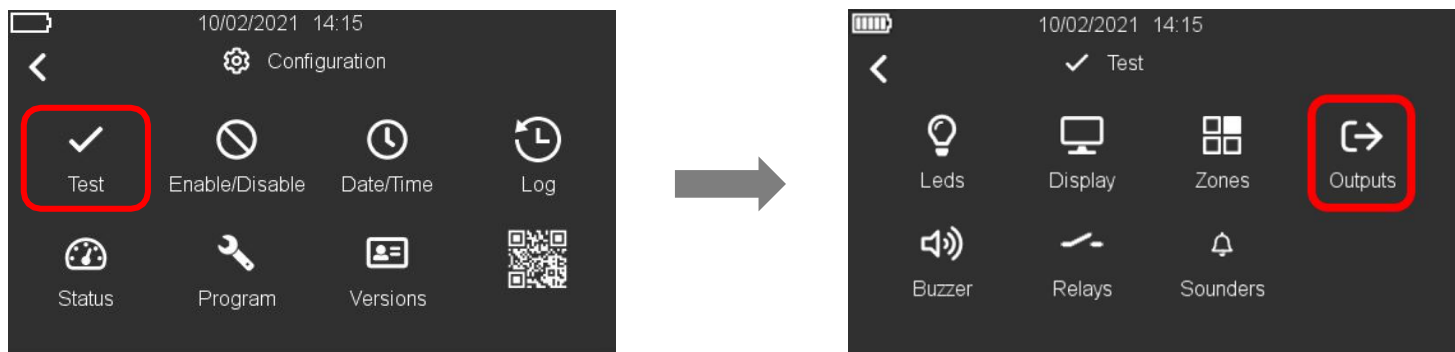

2. Click on the icon  near the Zone you would like to put in Test. The Test icon  will be displayed near the selected Zone and status label will be updated; in this example Z02.
Press the back arrow  for go back to the main screen.
3. To end the Test, click on the related Test icon  of the Zone in test. The Enabled icon  will be displayed near the Zone and status label will be updated.
Press the back arrow  to go back to the main screen.

19.3 System test – Outputs

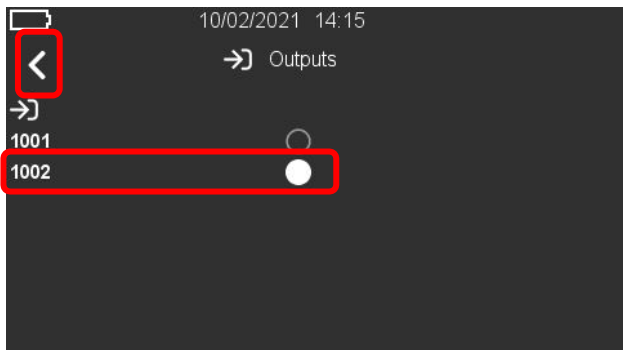

1. Follow the steps to enter in “Configuration” menu, select “Test” to access the available test options, then select “Outputs” icon to view the list of the addressable Outputs installed in the system.



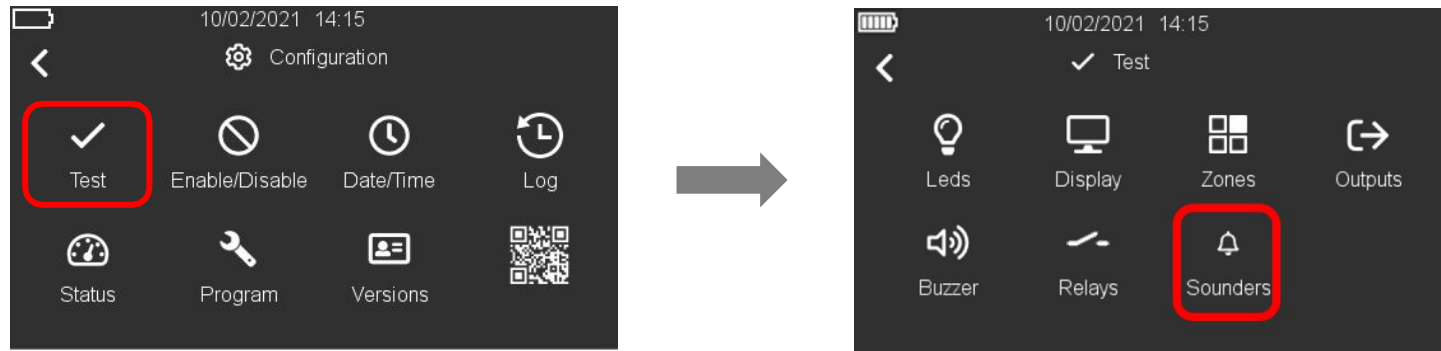

2. Click on the empty circle near the output you would like to activate it. In this example, we are activating the Output with address 002 in loop1.
3. To end the Output test, press on the full dot so the dot next to the desired output device appears empty. Press the back arrow  to go back to the previous screen.

19.4 System test – Sounders

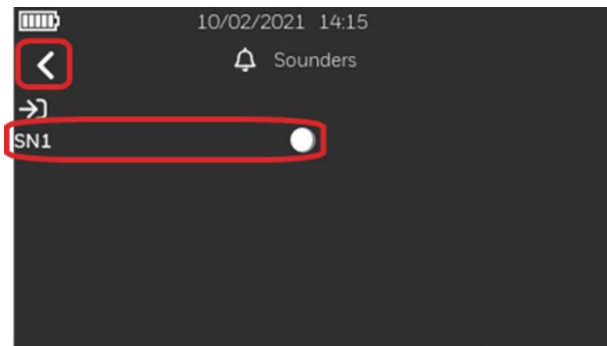

1. Follow the steps 1 and 2 to enter in “Configuration” menu, select “Test” to access the available test options, then select “Sounders” icon to view the list of the panel outputs (on-board Sounder Circuits).



2. Click on the empty circle near the Sounder you would like to activate it. In this example, we are activating the sounder circuit 1 (SN1).
3. To end the Sounder test, press on the full dot, so that the dot next to the desired sounder circuit appears empty. Press the back arrow  to go back to the previous screen.

20 MAINTENANCE

A logbook should be used for recording day to day events in the system, it should be used to record service and maintenance work visits.

ROUTINE TESTING

To ensure that the system is fully operational it must be routinely tested in accordance with the requirements of EN 54-14, national code of practice and local requirements.

BATTERIES

As a minimum, replace the panel batteries that provides power to the system every four years. The battery units must always be disposed of in accordance with the battery manufacturer's recommendations and local regulations. Please replace the batteries for equivalent ones otherwise the standby requirement will not be met.

FAULT MONITORING AND RECTIFICATION

Where there is an active fault in the system, which is displayed at the panel, then this fault can be interrogated by a trained person. To assist in decision making as to the cause and solution, see section headed Messages and their meaning.

CLEANING

The panel case may be cleaned periodically by wiping with a soft, damp lint-free cloth. Do not use any solvents. Before cleaning the touch screen ensure the panel is at access level 1 and take care to use a clean cloth to clean the touch screen.

21 UPGRADING PANEL FIRMWARE

Over the course of a fire alarm panel's life, it becomes necessary to upgrade the panel's firmware for various reasons; whether this be due to essential life safety maintenance or feature enhancements. Morley-IAS Plus allows users a simple way to upgrade. Below are the necessary steps required to successfully upgrade the panel firmware.

You will require: Windows™ PC *with internet access, USB A to B lead. – *Internet access required for firmware download only.

1. Download the latest firmware version from the Morley-IAS Plus technical website: <https://buildings.honeywell.com/gb/en/lp/morleytech>. Please ensure you select the appropriate firmware for your specific model of control panel.
2. Once the firmware file is downloaded, extract/uncompress the compressed folder.
3. Power OFF the panel mains supply. Open the panel front cover and disconnect the panel batteries.

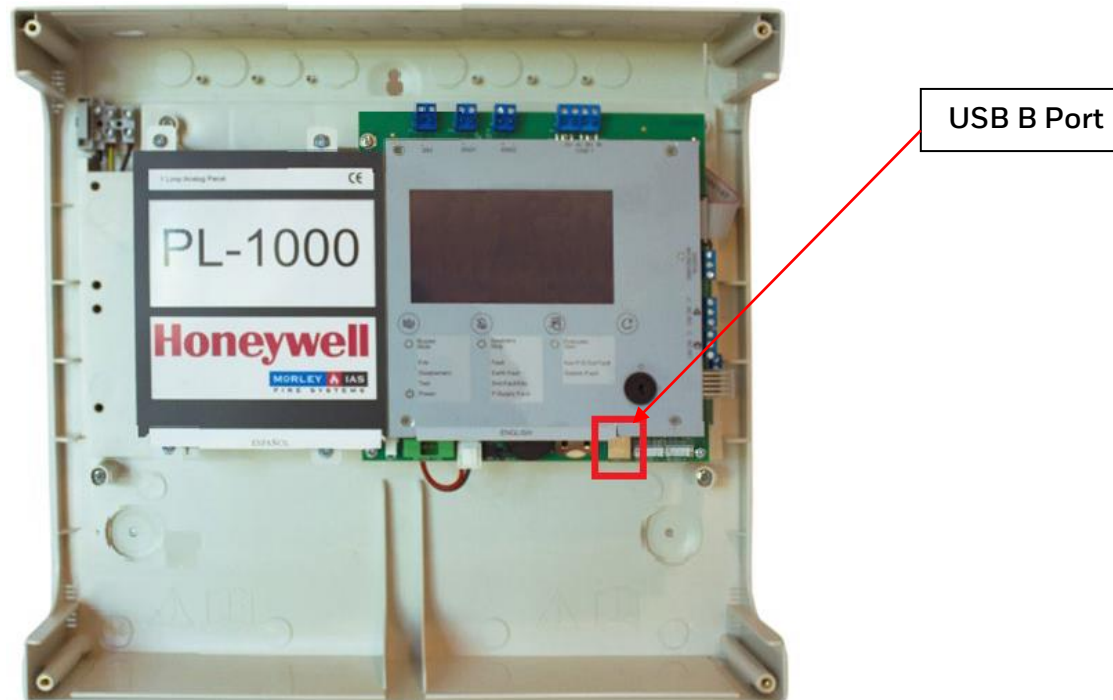

4. Connect the USB cable from the PC to the USB B port.

- 5. Press and hold both the Silence Sounders and Mute Buzzer buttons while returning the mains supply. Keep both buttons pressed for approximately 5 seconds. After 5 seconds, the panel will enter the bootloader mode. Once in bootloader mode, identified by the continuous buzzer sound and the blank display, release the buttons.



- 6. Ensure all below files are present in the extracted/uncompressed folder. Double click on FlashFirmware_PL1000 to start the firmware update.

- dfu-util
- FlashFirmware_PL1000
- libusb-1.0.dll
- LTPlus_hnyl.bin



Please note: It is crucial to NOT remove power to the panel during this process, as it may lead to an incomplete update and potential system failure.

7. The firmware update will start in a command window, as below. Progress of the firmware update is indicated at the bottom, as shown.

```
C:\WINDOWS\system32\cmd.exe

C:\Morley_Plus_Firmwares>ECHO OFF
ECHO is off.
No File Provided
dfu utility found
Devnum for 1fc9:00a1 is 16
Flashing Firmware

Waiting for 0 seconds, press a key to continue ...
dfu-util 0.11

Copyright 2005-2009 Weston Schmidt, Harald Welte and OpenMoko Inc.
Copyright 2010-2021 Tormod Volden and Stefan Schmidt
This program is Free Software and has ABSOLUTELY NO WARRANTY
Please report bugs to http://sourceforge.net/p/dfu-util/tickets/

Warning: Invalid DFU suffix signature
A valid DFU suffix will be required in a future dfu-util release
Opening DFU capable USB device...
Device ID 1fc9:00a1
Device DFU version 0101
Claiming USB DFU Interface...
Setting Alternate Interface #0 ...
Determining device status...
DFU state(2) = dfuIDLE, status(0) = No error condition is present
DFU mode device DFU version 0101
Device returned transfer size 512
Copying data from PC to DFU device
Download [=====] 48% 466432 bytes
```

```
C:\WINDOWS\system32\cmd.exe
Flashing Firmware

Waiting for 0 seconds, press a key to continue ...
dfu-util 0.11

Copyright 2005-2009 Weston Schmidt, Harald Welte and OpenMoko Inc.
Copyright 2010-2021 Tormod Volden and Stefan Schmidt
This program is Free Software and has ABSOLUTELY NO WARRANTY
Please report bugs to http://sourceforge.net/p/dfu-util/tickets/

Warning: Invalid DFU suffix signature
A valid DFU suffix will be required in a future dfu-util release
Opening DFU capable USB device...
Device ID 1fc9:00a1
Device DFU version 0101
Claiming USB DFU Interface...
Setting Alternate Interface #0 ...
Determining device status...
DFU state(2) = dfuIDLE, status(0) = No error condition is present
DFU mode device DFU version 0101
Device returned transfer size 512
Copying data from PC to DFU device
Download [=====] 100% 970392 bytes
Download done.
DFU state(6) = dfuMANIFEST-SYNC, status(0) = No error condition is present
DFU state(8) = dfuMANIFEST-WAIT-RESET, status(0) = No error condition is present
Resetting USB to switch back to runtime mode
Done!

Waiting for 11 seconds, press a key to continue ...
```

- 8. Once the upload is complete, successful update message will appear and the panel will automatically reboot displaying the Honeywell Morley-IAS logo.
- 9. The panel is now operational. Go to the version menu and verify the firmware version of the panel.
- 10. Next the Date and Time MUST be re-entered. Go to Date/Time menu and set the correct date and time.

Congratulations, by successfully following the steps above, you now have updated the Morley-IAS PL-1000 panel firmware.

22 FRONT LABEL LANGUAGES AVAILABLE

A set of labels is provided with the panel to identify the LED and Functions. Example of languages may include: English, Spanish, Portuguese, Italian, French, German, Dutch, Romanian, and others.

| | | | | | | | | | | | |
|---|--|---|--|--|---|---|--|---|--|---|---|
| Buzzer Mute Fire Disablement Test Power | Sounders Stop Fault Earth Fault Snd.Fault/Dis. P.Supply Fault | Evacuate Aux.P.S.Out Fault System Fault | Silenciar Zumbador Alarma Anulada Prueba Servicio | Silenciar Sirenas Avería General Fallo Tierra Sir.Fallo/Anuladas Fallo Alimentación | Evacuación Avería Alim. Aux Fallo Sistema | Tacitazione Buzzer Allarme Esclusione Test Alimentazione | Tacitazione Guasto Guasto Terra Sir. Guas./Esc. Guasto Alim. | Evacuazione Guasto Alim. Aux Guasto Sistema | Stop Zoemer Alarm Buiten Dienst In Test Voeding | Stop/Herst. Sirenes Algemene Storing Aardfout Sirenes in Storing/ Buiten Dienst Storing Voeding | Evacuatie Storing Aux. Voeding Systeem |
| ENGLISH | | | ESPAÑOL | | | ITALIANO | | | NEDERLANDS | | |
| Arrêt Ronfleur Feu Hors Service Test Service | Arrêt Sirenes Défaut Défaut Terre Défaut Sir/Hors S. Défaut Alim. | Evacuation Défaut Alim. Aux. Défaut Système | Summer AUS FEUER Abschaltung Testbetrieb Betrieb | Akustik AB / AN Sammel-störung Erdschluss Akustik AB / GESTÖRT Störung Netzteil | Evakuierung Störung Ext.Netzteil System-störung | Silenciar Besouro Alarme Anulada Teste Serviço | Silenciar Sirenes Avaria Avaria Terra Sir. Avaria/Anul Avaria Alim. | Evacuação Avaria Alim. Aux Avaria Sistema | Stop Buzzer Alarmă Dezactivare Test Funcționare | Sirene Defect Punere la pământ Defect/Dezactivare sirene Defect alimentare | Evacuare Defect Aux. Defect sistem |
| FRANÇAIS | | | DEUTSCH | | | PORTUGUÊS | | | ROMÂNĂ | | |

Fig. 24: Labels multilanguage for front panel LED and Functions

23 PRODUCT LIST

Plus closed Loop Panel Advanced Protocol
up to 159 detectors plus 159 input/output modules expandable.
Morley PL-1000

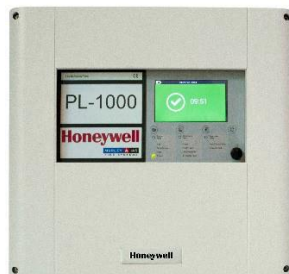

Loop Module closed loop Panel Advanced Protocol
up to 159 detectors plus 159 input/output modules.
Morley PL-LIB-01



23.1 Compatible Devices

| Detectors | Detectors | Manual Call Points | I/O Modules | AV Devices | Wireless Devices |
|---------------|--------------|--------------------|-------------|-------------|------------------|
| MI-PSE-S2 | MI-LZR-S3I | MI-MCP-FLEX | MI/D240CMOE | MI-BGL-PC-I | MI-GATE |
| MI-PSE-S2I | MI-OSI-RIE | MI-MCP-FLEX/C | MI/D2ICMOE | MI-BRH-PC-I | 22051E-RF |
| MI-PSE-S2-IV | HM-PSE-I | MI-MCP-FLEX-I | MI/DMM2IE | MI-BRS-PC-I | 22051TLE-RF |
| MI-PTIR-S2 | HM-PSE-S2 | MI-MCP-FLEX-I/C | MI/DCMOE | MI-BSO-DD-I | 52051E-RF |
| MI-PTIR-S2I | HM-PSE-S2-I | MI-MCP-GLASS | MI/DMMIE | MI-BSO-DD-N | 52051RE-RF |
| MI-PTIR-S2-IV | HM-PTSE | MI-MCP-GLASS-I | MI-D240CMOE | MI-BSO-PP-I | M200F-RF |
| MI-PTSE-S2 | HM-PTSE-I | MI-WCP-R/I/SG | MI-DMMIE | MI-BSO-PP-N | M211E-RF |
| MI-PTSE-S2I | HM-RHSE | MI-WCP-R/I/SG/C | MI-D2ICMOE | MI-DSS-PC-I | R5A-RF |
| MI-PTSE-S2-IV | HM-RHSE-I | MI-WCP-R/SG | MI-DMM2IE | MI-DSS-PC-N | M200I-RF |
| MI-FHSE-S2 | HM-FHSE | MI-WCP-R/SF | MI-DCMOE | MI-WSO-PP-I | WSO-RR-RF |
| MI-FHSE-S2I | HM-FHSE-I | MI-WCP-R/I/SF/C | MI-MM3E-S2 | MI-WSO-PP-N | WSO-WW-RF |
| MI-FHSE-S2-IV | HM-PSE | HM-MCP-GLASS-AP | MI-IM10-S2I | MI-WSO-PR-I | WSF-RR-RF |
| MI-HTSE-S2 | HM-PSE-AP | | MI-CR6-S2I | MI-WSO-PR-N | WSF-WR-RF |
| MI-HTSE-S2I | HM-PTSE-AP | | | MI-WSS-PC-I | |
| MI-HTSE-S2-IV | HM-PSE-I-AP | | | MI-WSS-PC-N | |
| MI-RHSE-S2 | HM-PTSE-I-AP | | | MI-WSS-PR-I | |
| MI-RHSE-S2I | HM-RHSE-AP | | | MI-WSS-PR-N | |
| MI-RHSE-S2-IV | HM-RHSE-I-AP | | | MI-WST-PC-I | |
| | HM-FHSE-AP | | | MI-WST-PC-N | |
| | HM-FHSE-I-AP | | | MI-WST-PR-I | |
| | | | | MI-WST-PR-N | |

| Detectors | Detectors | Manual Call Points | I/O Modules | AV Devices | Wireless Devices |
|-----------|-----------|--------------------|-------------|--|------------------|
| | | | | WRL-PC-I05 WRL-RC-I05 WWL-PC-I05 WWL-RC-I05 WRA-PC-I05 WRA-RC-I05 WWA-PC-I05 WWA-RC-I05 | |

Honeywell House

Skimped Hill Lane

BRACKNELL

Berkshire, RG12 1EB

UK

M-169.1-SERIE-PL-EN Version 2024 / 04.2024

Technical changes reserved!

© 2024 Honeywell International Inc.

Honeywell

